

New
Line Up

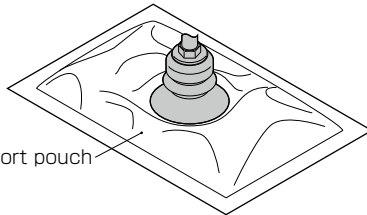

Vacuum Pad for Retort Pouch Vacuum Pad Bellows Series

- Suitable for soft work-pieces such as papers, plastic bags, etc. This pad has a characteristic of flexible motion.



Food package like a retort pouch

- Pad size : **12** sizes
- Pad material : **8** types
- Holder type : **5** types (Standard),
4 types (Small)

- Various selections of pad size, pad material and holder type.

Hot Newly added pad sizes and materials expand applicable work-piece.

- Downsized holders (A, B, C and D type) are available for space-saving.

No need to detach a holder when replacing vacuum pad.
Optional selection of Fall prevention valve and Vacuum Filter.

Hot Variety of selections in pad holder for "Copper alloy free" and against "low ozone concentration".

No copper based metal parts, HNBR, and FKM are adopted for seal rubber.

Hot Resin attachment to avoid suction marks on work-piece is now available.

Best suitable for transporting of glass, painting process and taking-out molded parts.



Model Designation (Example)

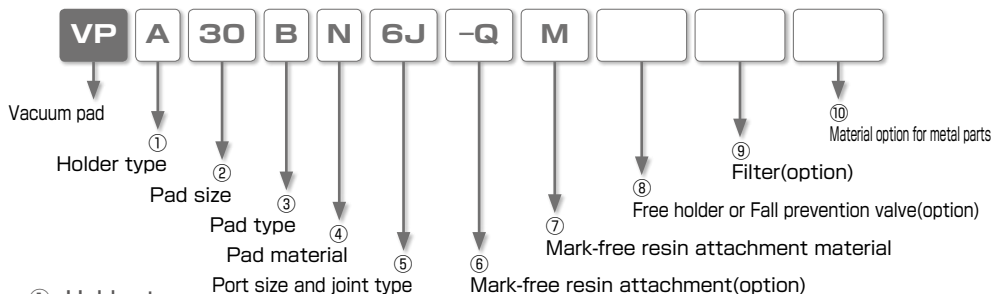

①. Holder type

Code	Standard	A	Code	Standard	B	Code	Standard	C
	Small	MA		Small	MB		Small	MC
Type		Fixed type / Top port	Type		Fixed type / Side port	Type		Spring type / Top port
Code	Standard	D	Code	Standard	F			
	Small	MD		Small	—			
Type		Spring type / Side port	Type		Spring type / Direct mount			

②. Pad size

Code	6	8	10	15	20	25	30	40	50	60	80	100
Dia. (mm)	ø6	ø8	ø10	ø15	ø20	ø25	ø30	ø40	ø50	ø60	ø80	ø100
Resin attachment	—	—	○	○	○	○	○	—	—	—	—	—

③. Pad type

Code	B											
Type	Bellows											

④. Pad material and application

Material	Nitrile rubber	Silicone rubber	Urethane rubber	Fluoro rubber	Conductive Silicone rubber	Conductive NBR rubber (Low resistance type)	HNBR	EPDM
Code	N	S	U	F	SE	NE	HN	EP
Application	Cardboard Plywood Iron plate Food-related Other general work-pieces	Semiconductors Taking out molded parts Thin work-pieces Food-related	Cardboard Plywood Iron plate	Chemical environment High temp. work-piece	Semiconductors Taking out molded parts Thin work-pieces Food-related	Semiconductors	Cardboard Plywood Iron plate Food-related Other general work-pieces For use under a low ozone concentration environment	Application that requires light-resistance or ozone-proof. For use in a moisture-containing atmosphere.

※ 1. The Conductive Silicone rubber is a silicone rubber capable of releasing static electricity. (Volume resistance: Max. 10⁹Ω·cm)

※ 2. The material of Conductive NBR rubber (low resistance) is a nitrile rubber. (Volume resistance: Max. 200Ω·cm)

※ 3. Pad material N and NE are not suitable for use under ozone environment.

※ 4. Holder types of VPMD, VPMD (Standard and "-S3" spec.) and VPC, VPD ("-S3" spec.) are not compliant with Japan Food Sanitation Act.

⑤. Port size and joint type

■ Standard type holder

Joint type	Push-in fitting	Barb fitting	Female thread
Code	6J	6B	01
O.D. x I.D.	ø6mm x ø4mm	ø6mm x ø4mm	Rp(G)1/8
Pad size	ø10mm ~ ø50mm		ø60mm ~ ø100mm

■ Small type holder

Joint type	Push-in fitting			Barb fitting		
Code	180J	3J	4J	3B	4B	6B
O.D. x I.D.	ø1.8mm x ø1mm	ø3mm x ø2mm	ø4mm x ø2.5mm	ø3mm x ø2mm	ø4mm x ø2.5mm	ø6mm x ø4mm
Pad size	ø6, ø8mm	ø6, ø8, ø10, ø15mm	ø10mm ~ ø30mm	ø6, ø8, ø10, ø15mm	ø20mm ~ ø30mm	

⑥. Mark-free resin attachment (option)

Code	-Q
Option	Mark-free resin attachment

⑦. Resin attachment material and application (When option ⑥ selected)

Material	PEEK	POM	Conductive PEEK
Code	K	M	KE
application	Semiconductor / liquid crystal production device	Various production line Food-related equipment Packaging machine	Semiconductor / liquid crystal production device Electric parts

※. Volume resistance of Conductive PEEK : $10^9 \sim 10^9 \Omega \cdot \text{cm}$

⑧. Free holder or Fall prevention valve (option)

Code	-FH	-FHH	-ECV
Option	Oscillating angle of free holder : 30°	Oscillating angle of free holder : 15°	Fall prevention valve

※. Free holder cannot be installed on small pad holder.

⑨. Filter (option)

Code	-F15	-F30
Pad size	ø10mm~ø20mm	ø30mm~ø50mm

⑩. Material option for metal parts

Code	No code	-S3
Material	Standard	Copper alloy free material

※ 1. Free holder, fall prevention valve and filter are not available when "-S3" is selected.

※ 2. "-S3" option ins not available for the model with a push-in fitting of ø3mm tube dia. with VPMA, VPMB, VPMC and VPMD holders.



Suction Force

Regarding suction force of bellows vacuum pad, the calculated suction force (theoretical suction force x safety factor) may not be assured, due to the characteristics of vacuum pad, vacuum level, pad material and work-piece, etc.

Select the proper item based on "Vacuum Pad Selection Guide (page 479)". Carry out any necessary evaluation with an actual system before approval. Bellows Series is not suitable for vertical lifting.

⚠ Detailed Safety Instructions

Before using PISCO products, be sure to read "Safety Instructions" and "Common Safety Instructions for Products Listed in This Catalog on page 43-49, and "Common Safety Instructions for Vacuum Pad" on page 477-478.

Warning

1. Since small vacuum pad holders are designed to be more lightweight than general holders, small type is inferior in load resistance. Secure an enough margin for a load setting and evaluate PISCO products with an actual system.
2. When replacing vacuum pad, refer to the structure of vacuum pad holder and pad, and tighten the screw with the described tightening torque in "Common safety instructions for Vacuum Pads" on page 477-478. Make sure that there is no looseness of the screw.
3. When installing bulkhead type pad holder, check the tightening torque for each holder and use proper tool to tighten the fixing nut. Make sure that there is no looseness of the nut. Excessive tightening of a fixing nut may deform the bulkhead part and result in malfunction of the keyway.
4. The vacuum pad rubber to be fit with the resin attachment must be Pisco vacuum pad bellows series. When the shapes of the resin attachment and the vacuum pad rubber do not match precisely, looseness of the resin attachment or large amount of leakage is caused.
5. Vacuum pad bellows series may stick to each other due to its material property, depending on usage conditions. Carry out the evaluation under an actual operating condition.

Caution

1. When using conductive vacuum pad, static electricity needs to be dissipated through a metal plate, etc., used to fix the holder. Also consider the conductivity when selecting the holder type. Otherwise, the static electricity remains on the vacuum pad.
2. Pad frames for pad dia. of $\varnothing 80$ mm or larger do not have conductivity. When using a conductive vacuum pad, static electricity needs to be dissipated through the vacuum pad.
3. When using a conductive vacuum pad with a holder equipped with free holder or vacuum filter (optional parts), static electricity needs to be dissipated through the vacuum pad.
4. The resin made lip of the attachment leaves less residual tracing mark, comparing to conventional rubber made vacuum pad. However, carry out the evaluation and check the residual mark on the work under an actual operating condition before use.
5. The vacuum leakage between the work-piece and the resin attachment influences the performance of the attachment more than a conventional rubber made vacuum pad. Do not use it in vacuum retention. Also the vacuum pressure drop must be minimized by securing the vacuum suction flow as much as possible.
6. Be sure to wash the suction surface of pad before operation. Adhered substances can cause tracing marks on work-pieces. Pay attention not to scratch suction surface and do not use organic solvent when washing.
7. Select the appropriate rubber material of bellows vacuum pad to be fit with the resin attachment in accordance with the operating conditions.

How to insert and disconnect

1. How to insert and disconnect tubes (Push-in fitting)

① Tube insertion

Insert a tube into Push-in fitting up to the tube end. Lock-claws bite the tube and fix it automatically, then the elastic sleeve seals around the tube.

Refer to "7. Instructions for Tube Insertion" under "Common Safety Instructions for Products Listed in This Catalog".

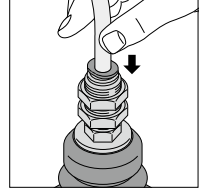

② Tube disconnection

The tube is disconnected by pushing release-ring to release Lock-claws.

Make sure to stop air supply before the tube disconnection.

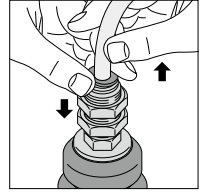

2. How to insert and disconnect tubes (Barb fitting)

① Tube insertion

Insert the barb into a tube up to the barb end. The outer shape of barb seals inside the tube. Use Tube Clamp Sleeve (※) to avoid the disconnection of tubes.

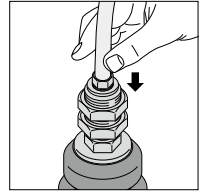

② Tube disconnection

Remove Tube Clamp Sleeve first, and pull the tube out.

※ Refer to Minimal fitting on P.266

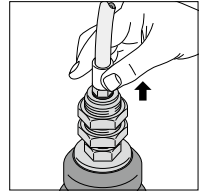

3. How to fix holder

In order to fix the vacuum pad holder, tighten the hexagonal nut with a spanner. Refer to the dimensional drawings for detail.

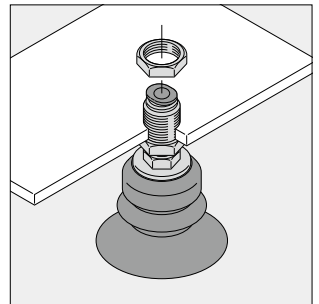



Vacuum Pad Series

Vacuum Pad Bellows Series

Standard Size List (Combinations with Standard Vacuum Pad Holder)

Fixed type / Top port / Push-in fitting or Parallel Female Thread



Type	Page	Pad size	Port size		
			6mm	G1/8	
VPA	573	6mm	●		
		8mm	●		
		10mm	●		
		15mm	●		
		20mm	●		
		25mm	●		
		30mm	●		
		40mm	●		
		50mm	●		
		60mm		●	
		80mm			●
		100mm			●

Fixed type / Side port / Push-in fitting or Parallel Female Thread



Type	Page	Pad size	Port size		
			6mm	G1/8	
VPB	574	6mm	●		
		8mm	●		
		10mm	●		
		15mm	●		
		20mm	●		
		25mm	●		
		30mm	●		
		40mm	●		
		50mm	●		
		60mm			●
		80mm			●
		100mm			●

Spring type / Top port / Push-in fitting or Parallel Female Thread



Type	Page	Pad size	Port size		
			6mm	G1/8	
VPC	575	6mm	●		
		8mm	●		
		10mm	●		
		15mm	●		
		20mm	●		
		25mm	●		
		30mm	●		
		40mm	●		
		50mm	●		
		60mm			●
		80mm			●
		100mm			●

Spring type / Side port / Push-in fitting or Parallel Female Thread



Type	Page	Pad size	Port size		
			6mm	G1/8	
VPD	576	6mm	●		
		8mm	●		
		10mm	●		
		15mm	●		
		20mm	●		
		25mm	●		
		30mm	●		
		40mm	●		
		50mm	●		
		60mm			●
		80mm			●
		100mm			●

Fixed type / Top port / Barb fitting



Type	Page	Pad size	Port size
			6mmx4mm
VPA	578	6mm	●
		8mm	●
		10mm	●
		15mm	●
		20mm	●
		25mm	●
		30mm	●
		40mm	●
		50mm	●

Fixed type / Side port / Barb fitting



Type	Page	Pad size	Port size
			6mmx4mm
VPB	579	6mm	●
		8mm	●
		10mm	●
		15mm	●
		20mm	●
		25mm	●
		30mm	●
		40mm	●
		50mm	●

Spring type / Top port / Barb fitting



Type	Page	Pad size	Port size
			6mmx4mm
VPC	580	6mm	●
		8mm	●
		10mm	●
		15mm	●
		20mm	●
		25mm	●
		30mm	●
		40mm	●
		50mm	●

Spring type / Side port / Barb fitting



Type	Page	Pad size	Port size
			6mmx4mm
VPD	581	6mm	●
		8mm	●
		10mm	●
		15mm	●
		20mm	●
		25mm	●
		30mm	●
		40mm	●
		50mm	●

VACUUM PAD

565

Standard Series

Sponge Series

Bellows Series

Spring type / Direct mount



Type	Page	Pad size	Male thread size
			M14×1mm
VPF	577	6mm	●
		8mm	●
		10mm	●
		15mm	●
		20mm	●
		25mm	●
		30mm	●
		40mm	●
		50mm	●

Vacuum Pad Rubber Only



Type	Page	Pad size	
VP	570	6mm	●
		8mm	●
		10mm	●
		15mm	●
		20mm	●
		25mm	●
		30mm	●
		40mm	●
		50mm	●
		60mm	●
		80mm	●
		100mm	●



Vacuum Pad Series

Vacuum Pad Bellows Series

Standard Size List (Combinations with Small Vacuum Pad Holder)

Fixed type / Top port / Push-in fitting



Type	Page	Pad size	Port size		
			1.8mm	3mm	4mm
VPMA	582	6mm	●	●	
		8mm	●	●	
		10mm	●	●	●
		15mm	●	●	●
		20mm			●
		25mm			●
30mm			●		

Fixed type / Side port / Push-in fitting



Type	Page	Pad size	Port size		
			1.8mm	3mm	4mm
VPMB	583	6mm	●	●	
		8mm	●	●	
		10mm	●	●	●
		15mm	●	●	●
		20mm			●
		25mm			●
		30mm			●

Fixed type / Top port / Barb fitting



Type	Page	Pad size	Port size		
			3mm×2mm	4mm×2.5mm	6mm×4mm
VPMA	586	6mm	●	●	
		8mm	●	●	
		10mm	●	●	
		15mm	●	●	
		20mm		●	●
		25mm		●	●
30mm		●	●		

Fixed type / Side port / Barb fitting



Type	Page	Pad size	Port size		
			3mm×2mm	4mm×2.5mm	6mm×4mm
VPMB	587	6mm	●	●	
		8mm	●	●	
		10mm	●	●	
		15mm	●	●	
		20mm		●	●
		25mm		●	●
		30mm		●	●

Spring type / Top port / Push-in fitting



Type	Page	Pad size	Port size		
			1.8mm	3mm	4mm
VPMC	584	6mm	●	●	
		8mm	●	●	
		10mm	●	●	●
		15mm	●	●	●
		20mm			●
		25mm			●
30mm			●		

Spring type / Side port / Push-in fitting



Type	Page	Pad size	Port size		
			1.8mm	3mm	4mm
VPMD	585	6mm	●	●	
		8mm	●	●	
		10mm	●	●	●
		15mm	●	●	●
		20mm			●
		25mm			●
		30mm			●

Spring type / Top port / Barb fitting



Type	Page	Pad size	Port size		
			3mm×2mm	4mm×2.5mm	6mm×4mm
VPMC	588	6mm	●	●	
		8mm	●	●	
		10mm	●	●	
		15mm	●	●	
		20mm		●	●
		25mm		●	●
30mm		●	●		

Spring type / Side port / Barb fitting



Type	Page	Pad size	Port size		
			3mm×2mm	4mm×2.5mm	6mm×4mm
VPMD	589	6mm	●	●	
		8mm	●	●	
		10mm	●	●	
		15mm	●	●	
		20mm		●	●
		25mm		●	●
		30mm		●	●

VACUUM PAD

567

Standard Series
Sponge Series
Bellows Series

Drawing of Vacuum Pad and Holder Joint

●VP6, 8B□

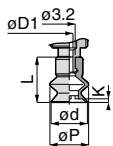

●VP10, 15B□

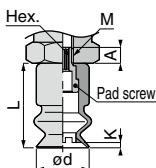

●VP20, 25, 30B□

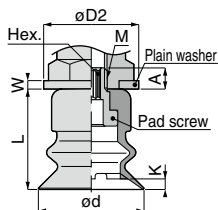

●VP40, 50B□

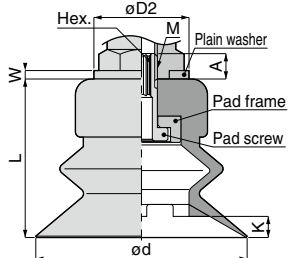

●VP60B□

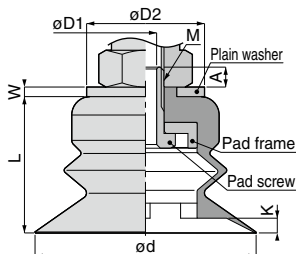

●VP80, 100B□A

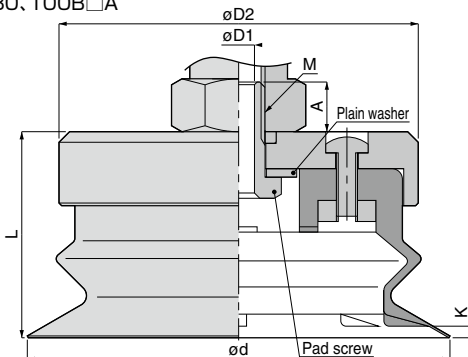

Unit : mm

Model code	Vacuum Pad O.D. øD	L	Inner lip height K	Fixing screw M	A	Hex.	øD1	øD2	øP	W
VP6B[4]	6	10	0.6	—	—	—	—	—	6.7	—
VP8B[4]	8	10	0.8	—	—	—	—	—	8.6	—
VP10B[4]	10	16	1	M4 × 0.7	3	2	—	—	—	—
VP15B[4]	15	16	1.5	M4 × 0.7	—	2	—	—	—	—
VP20B[4]	20	19	2	M6 × 1	4	3	—	18	—	1.6
VP25B[4]	25	19	2	M6 × 1	—	3	—	—	—	—
VP30B[4]	30	23	2.5	M6 × 1	5	3	—	18	—	1.6
VP40B[4]	40	30	4	M6 × 1	5.5	3	—	22	—	1.6
VP50B[4]	50	32	4	M6 × 1	5.5	3	—	22	—	1.6
VP60B[4]	60	40.5	4	M10 × 1.5	—	14	6	32	—	2.6
VP80B[4]A	80	39	2	M10 × 1.5	9.4	14	6	68	—	—
VP100B[4]A	100	45	2.5	M10 × 1.5	—	14	6	85	—	—

※ [4] in Model code : Replaced with Pad rubber material code. Refer to page 561 for details.



Vacuum Pad Bellows Series

■ Dimensions of Pad insertion part

●VP6, 8B□

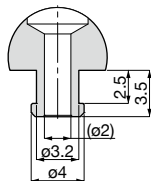

■ Pad screw dimensions

●VP10, 15B□

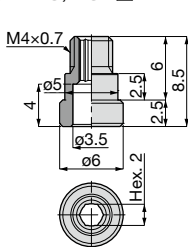

●VP20~50B□

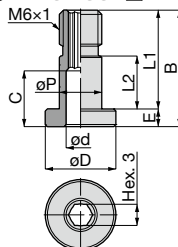

●VP60~100B□

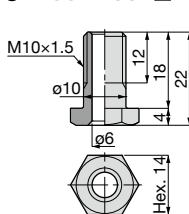

Unit : mm

Pad screw model code	φD	φd	φP	E	C	B	L1	L2	Weight (g)	Applicable pad model code
VPM46-6	-	-	-	-	-	-	-	-	0.8	VP10, 15B□
VPM610-8	10	4.5	7	2.5	5	10.5	8	3.5	2.5	VP20, 25B□
VPM612-10	12	4.5	7	3	6	13	10	4	3.9	VP30B□
VPM610-15	10	4.1	6	2.5	7.9	16.5	14	7.5	3.1	VP40, 50B□
VPM1018	-	-	-	-	-	-	-	-	9.5	VP60~100B□

569

Standard Series

Sponge Series

Bellows Series

■ Plain washer dimensions

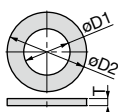

Unit : mm

Plain washer model code	O.D. φD2	I.D. φD1	T	Weight (g)	Applicable pad model code
HW10.5×18×1.6	18	10.5	1.6	2	VP20~30B□
HW10.5×22×1.6	22	10.5	1.6	3.5	VP40, 50, 80, 100B□
HW32×17×2.6	32	17	2.6	12	VP60B□

■ Pad support dimensions

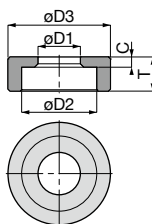

Unit : mm

Pad support model code	I.D. φD1	I.D. φD2	O.D. φD3	T	C	Weight (g)	Applicable pad model code
VPW40	6.2	11	15	5	1.5	1.4	VP40B□
VPW50	6.2	12	20	4.3	1.5	2.8	VP50B□
VPW60	10.2	23	28	7	3	6.8	VP60B□

Vacuum Pad Dimension

VP 6B □ Weight : 0.3g[0.4g]

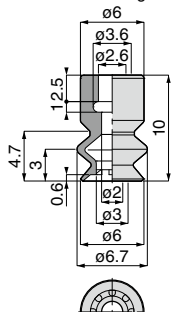

VP 8B □ Weight : 0.3g[0.4g]

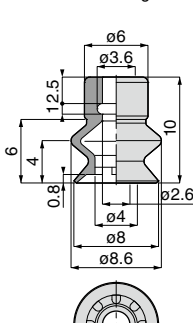

VP 10B □ Weight : 0.8g[1.3g]

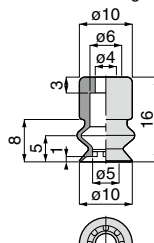

VP 15B □ Weight : 1.2g[1.9g]

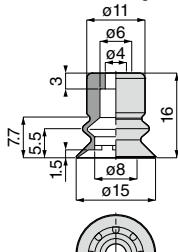

VP 20B □ Weight : 2.1g[3.3g]

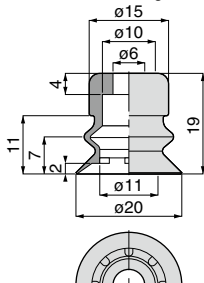

VP 25B □ Weight : 2.9g[4.6g]

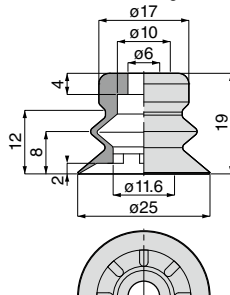

VP 30B □ Weight : 3.9g[6.2g]

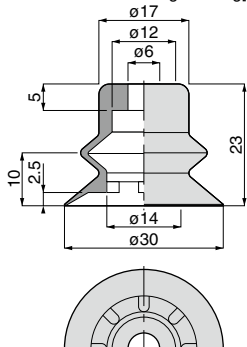

VP 40B □ Weight : 11g[17g]

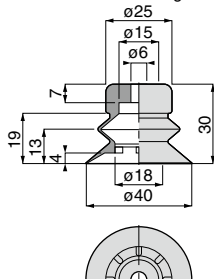

VP 50B □ Weight : 15g[22g]

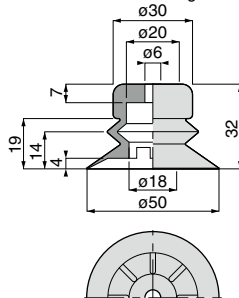

※ Weight in [] is the weight of Fluoro rubber.

VP 60B□ Weight : 27g[43g]

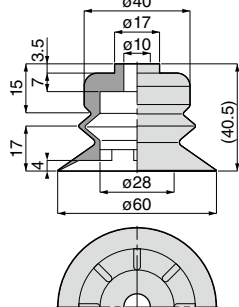

VP 80B□ Weight : 42g[67g]

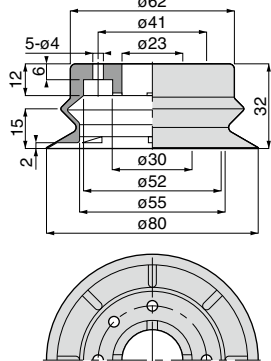

VP 100B□ Weight : 80g[129g]

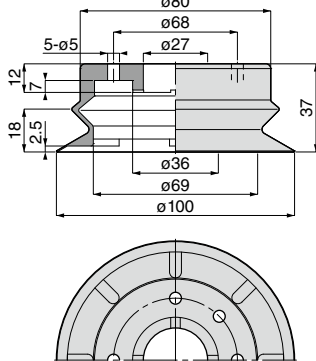

VP 80B□A (Vacuum pad with frame)

Weight : 125g[150g]

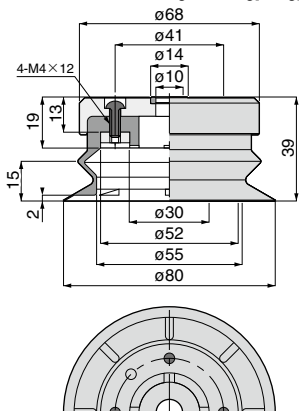

VP 100B□A (Vacuum pad with frame)

Weight : 224g[273g]

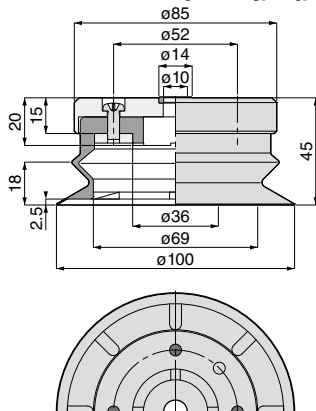

※ Weight in [] is the weight of Fluoro rubber.

■ Dimensions of vacuum pad with mark-free resin attachment



Unit : mm

■ Model code for bellows pad with resin attachment

VP 10B[4]-**Q**[7] Weight : 1.1g[1.6g]

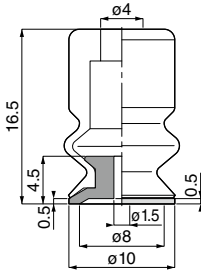

■ Model code for resin attachment alone

VP 10BQ[7]-**AT** Weight : 0.3g

■ Model code for bellows pad with resin attachment

VP 15B[4]-**Q**[7] Weight : 1.8g[2.5g]

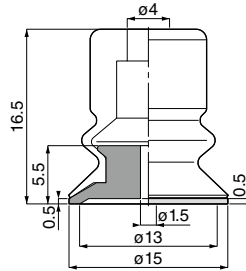

■ Model code for resin attachment alone

VP 15BQ[7]-**AT** Weight : 0.6g

■ Model code for bellows pad with resin attachment

VP 20B[4]-**Q**[7] Weight : 3.4g[4.6g]

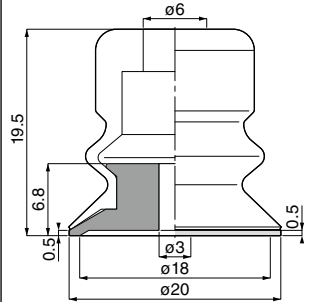

■ Model code for resin attachment alone

VP 20BQ[7]-**AT** Weight : 1.3g

■ Model code for bellows pad with resin attachment

VP 25B[4]-**Q**[7] Weight : 4.9g[6.6g]

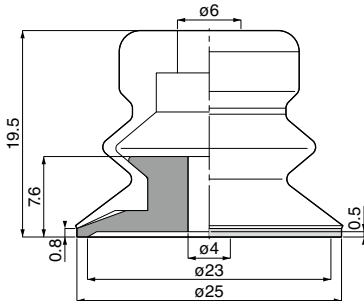

■ Model code for resin attachment alone

VP 25BQ[7]-**AT** Weight : 2g

■ Model code for bellows pad with resin attachment

VP 30B[4]-**Q**[7] Weight : 7.3g[9.6g]

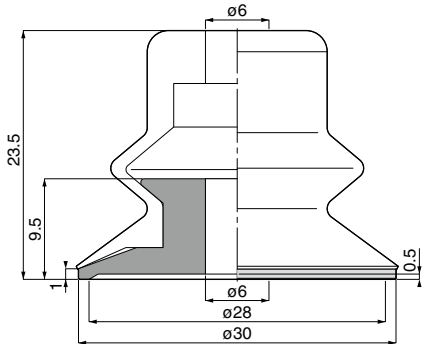

■ Model code for resin attachment alone

VP 30BQ[7]-**AT** Weight : 3.4g

- ※ [4] : Replaced with Pad rubber material code. Refer to page 561 for details.
- ※ [7] : Replaced with Resin attachment material code. Refer to page 562 for details.
- ※ . Weights in [] are for Fluoro rubber pad with a resin attachment.

VPA Fixed type / Top port / Push-in fitting



RoHS compliant

Copper alloy free

Selectable

VACUUM PAD



● VPA6, 8B□

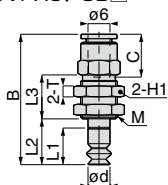

● VPA10, 15B□

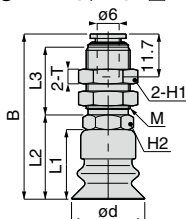

● VPA20~50B□

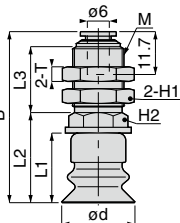

● VPA60~100B□

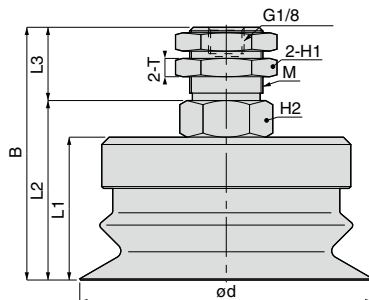

Unit : mm

Model code	Pad O.D. ød	Thread M	B	L1	L2	L3	Hex. H1	Hex. H2	T	Weight (g)	CAD file name
VPA6B ^[4] 6J ^[10]	6	M10 × 1	35.6	10	12.5	12	12	—	3	Now preparing	Refer to PISCO website.
VPA8B ^[4] 6J ^[10]	8	M10 × 1	35.6	10	12.5	12	12	—	3		
VPA10B ^[4] 6J ^[6] 7 ^[10]	10	M12 × 1	42.1	16	20	18.5	14	12	4		
VPA15B ^[4] 6J ^[6] 7 ^[10]	15	M12 × 1	42.1	16	20	18.5	14	12	4		
VPA20B ^[4] 6J ^[6] 7 ^[10]	20	M14 × 1	46.7	19	24.6	18	17	14	4		
VPA25B ^[4] 6J ^[6] 7 ^[10]	25	M14 × 1	46.7	19	24.6	18	17	14	4		
VPA30B ^[4] 6J ^[6] 7 ^[10]	30	M14 × 1	50.7	23	28.6	18	17	14	4		
VPA40B ^[4] 6J ^[10]	40	M14 × 1	57.7	30	35.6	18	17	14	4		
VPA50B ^[4] 6J ^[10]	50	M14 × 1	59.7	32	37.6	18	17	14	4		
VPA60B ^[4] 01 ^[10]	60	M20 × 1	70.5	40.5	53.1	20	24	22	5		
VPA80B ^[4] 01 ^[10]	80	M20 × 1	69	39	49	20	24	22	5		
VPA100B ^[4] 01 ^[10]	100	M20 × 1	75	45	55	20	24	22	5		

※ [4] : Replaced with Pad rubber material code. Refer to page 561 for details.

※ [6] : Replaced with "-Q" for mark-free resin attachment.

※ Add extra lengths below to the dimension B in the table above for dimension including a resin attachment.

Pad O.D. (mm)	ø10	ø15	ø20	ø25	ø30
Length added to dimension B (mm)	0.5	0.5	0.5	0.8	1

※ [7] : Replaced with Resin attachment material code. Refer to page 562 for details.

※ [10] : Replaced with "-S3" for "Copper alloy free".

※ Nitrile rubber (N) and Conductive NBR (Low resistance) (NE) are not suitable for measures against low ozone concentration.

※ Bulkhead nut tightening torque

- Pad dia. : ø10mm ▶ 12 ~ 14N·m, ▪ Pad dia. : ø20 ~ ø50mm ▶ 18 ~ 21N·m, ▪ Pad dia. : ø80mm ▶ 19 ~ 21N·m

VPB Fixed type / Side port / Push-in fitting

RoHS compliant
Copper alloy free
Selectable



●VPB6、8B□

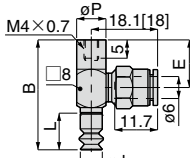

●VPB10、15B□

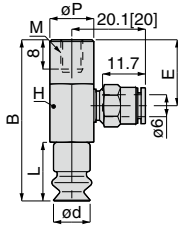

●VPB20~50B□

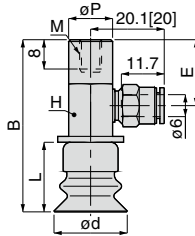

●VPB60~100B□

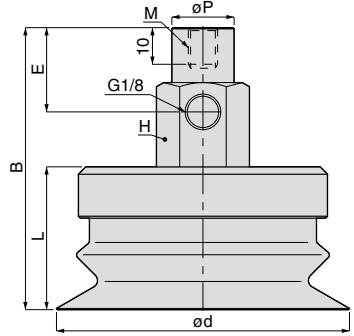

Unit : mm

Model code	Pad O.D. ød	Thread M	B	L	øP	E	Hex. H	Weight (g)	CAD file name
VPB6B ^④ 6J ^⑦ ⑩	6	M4 × 0.7	30	10	8	13	—	Now preparing	Refer to PISCO website.
VPB8B ^④ 6J ^⑦ ⑩	8	M4 × 0.7	30	10	8	13	—		
VPB10B ^④ 6J ^⑦ ⑩	10	M6 × 1	44	16	12	18	12		
VPB15B ^④ 6J ^⑦ ⑩	15	M6 × 1	44	16	12	18	12		
VPB20B ^④ 6J ^⑦ ⑩	20	M6 × 1	47	19	12	18	12		
VPB25B ^④ 6J ^⑦ ⑩	25	M6 × 1	47	19	12	18	12		
VPB30B ^④ 6J ^⑦ ⑩	30	M6 × 1	51	23	12	18	12		
VPB40B ^④ 6J ^⑦ ⑩	40	M6 × 1	58	30	12	18	12		
VPB50B ^④ 6J ^⑦ ⑩	50	M6 × 1	60	32	12	18	12		
VPB60B ^④ 01 ^⑩	60	M8 × 1.25	78.5	40.5	17	23	22		
VPB80B ^④ 01 ^⑩	80	M8 × 1.25	77	39	17	23	22		
VPB100B ^④ 01 ^⑩	100	M8 × 1.25	83	45	17	23	22		

※ . Value in [] is the dimension of a "-S3" spec model.

※ . ④ : Replaced with Pad rubber material code. Refer to page 561 for details.

※ . ⑦ : Replaced with "-Q" for mark-free resin attachment.

※ . Add extra lengths below to the dimension B in the table above for dimension including a resin attachment.

Pad O.D. (mm)	ø10	ø15	ø20	ø25	ø30
Length added to dimension B (mm)	0.5	0.5	0.5	0.8	1

※ . ⑩ : Replaced with Resin attachment material code. Refer to page 562 for details.

※ . ⑩ : Replaced with "-S3" for "Copper alloy free".

※ . Nitrile rubber (N) and Conductive NBR (Low resistance) (NE) are not suitable for measures against low ozone concentration.

VPC Spring type / Top port / Push-in fitting



RoHS compliant
Copper alloy free
Selectable

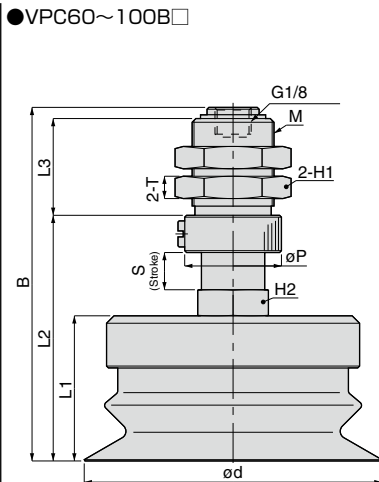
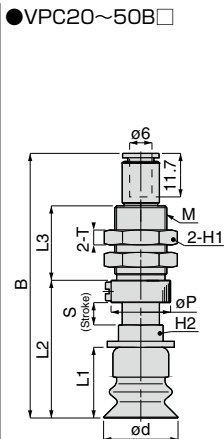
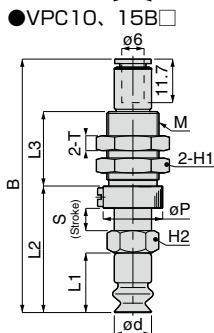
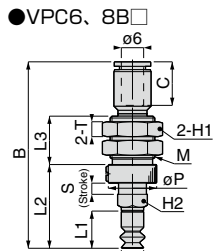

VACUUM PAD

Unit : mm

Model code	Pad O.D. ød	Thread M	B	L1	L2	L3	øP	Stroke S	Hex. H1	Hex. H2	T	Spring force (N)	Weight (g)	CAD file name
VPC6B ^[4] 6J ^[6] 10	6	M12×1	50.1[50]	10	22.5	13	13	3	14	8	4	0.9~1.9	Now preparing	Refer to PISCO website.
VPC8B ^[4] 6J ^[6] 10	8	M12×1	50.1[50]	10	22.5	13	13	3	14	8	4	0.9~1.9		
VPC10B ^[4] 6J ^[6] 710	10	M14×1	68.1[68]	16	34	20	16	6	17	12	4	4.0~7.1		
VPC15B ^[4] 6J ^[6] 710	15	M14×1	68.1[68]	16	34	20	16	6	17	12	4	4.0~7.1		
VPC20B ^[4] 6J ^[6] 710	20	M14×1	71.1[71]	19	37	20	16	6	17	12	4	7.0~12.6		
VPC25B ^[4] 6J ^[6] 710	25	M14×1	71.1[71]	19	37	20	16	6	17	12	4	7.0~12.6		
VPC30B ^[4] 6J ^[6] 710	30	M14×1	75.1[75]	23	41	20	16	6	17	12	4	7.0~12.6		
VPC40B ^[4] 6J ^[6] 10	40	M14×1	82.1[82]	30	48	20	16	6	17	12	4	7.0~12.6		
VPC50B ^[4] 6J ^[6] 10	50	M14×1	84.1[84]	32	50	20	16	6	17	12	4	7.0~12.6		
VPC60B ^[4] 0110	60	M22×1	96.5	40.5	70.1	26	26	10	27	19	6	10.1~15.8		
VPC80B ^[4] 0110	80	M22×1	95	39	66	26	26	10	27	19	6	10.1~15.8		
VPC100B ^[4] 0110	100	M22×1	101	45	72	26	26	10	27	19	6	10.1~15.8		

※ . Value in [] is the dimension of a "S3" spec model.

※ . [4] : Replaced with Pad rubber material code. Refer to page 561 for details.

※ . [6] : Replaced with "-Q" for mark-free resin attachment.

※ . Add extra lengths below to the dimension B in the table above for dimension including a resin attachment.

Pad O.D. (mm)	ø10	ø15	ø20	ø25	ø30
Length added to dimension B (mm)	0.5	0.5	0.5	0.8	1

※ . [7] : Replaced with Resin attachment material code. Refer to page 562 for details.

※ . [10] : Replaced with "-S3" for "Copper alloy free".

※ . Nitrile rubber (N) and Conductive NBR (Low resistance) (NE) are not suitable for measures against low ozone concentration.

※ . Bulkhead nut tightening torque

▪ Pad dia. : ø10~ø50mm ▶ 4.5~6N-m. ▪ Pad dia. : ø80mm ▶ 16~20N-m



VPD Spring type / Side port / Push-in fitting

RoHS compliant

Copper alloy free

Selectable

●VPD6、8B□

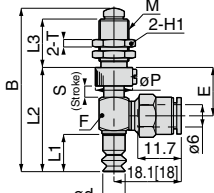

●VPD10、15B□

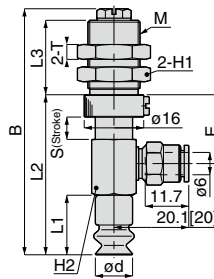

●VPD20~50B□

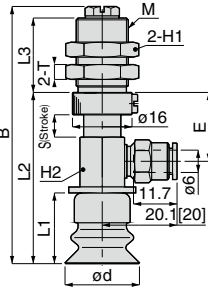

●VPD60~100B□

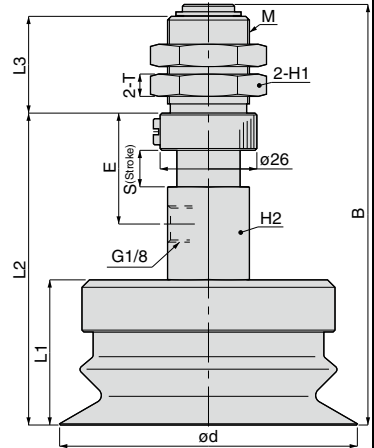

Unit : mm

Model code	Pad O.D. σd	Thread M	B	L1	L2	L3	Stroke S	E	Hex. H1	Hex. H2	T	Spring force (N)	Weight (g)	CAD file name
VPD6B ^④ 6J ^⑦ 10	6	M8×0.75	44[43.9]	10	28	13	3	13	10	—	2	0.9~1.9		
VPD8B ^④ 6J ^⑦ 10	8	M8×0.75	44[43.9]	10	28	13	3	13	10	—	2	0.9~1.9		
VPD10B ^④ 6J ^⑦ 10	10	M14×1	66.1[66]	16	43	20	6	18.5	17	12	4	4.0~7.1		
VPD15B ^④ 6J ^⑦ 10	15	M14×1	66.1[66]	16	43	20	6	18.5	17	12	4	4.0~7.1		
VPD20B ^④ 6J ^⑦ 10	20	M14×1	69.1[69]	19	46	20	6	18.5	17	12	4	7.0~12.6		
VPD25B ^④ 6J ^⑦ 10	25	M14×1	69.1[69]	19	46	20	6	18.5	17	12	4	7.0~12.6		
VPD30B ^④ 6J ^⑦ 10	30	M14×1	73.1[73]	23	50	20	6	18.5	17	12	4	7.0~12.6		
VPD40B ^④ 6J ^⑦ 10	40	M14×1	80.1[80]	30	57	20	6	18.5	17	12	4	7.0~12.6		
VPD50B ^④ 6J ^⑦ 10	50	M14×1	82.1[82]	32	59	20	6	18.5	17	12	4	7.0~12.6		
VPD60B ^④ 0110	60	M22×1	114.5	40.5	88.1	26	10	30	27	22	6	10.1~15.8		
VPD80B ^④ 0110	80	M22×1	113	39	84	26	10	30	27	22	6	10.1~15.8		
VPD100B ^④ 0110	100	M22×1	119	45	90	26	10	30	27	22	6	10.1~15.8		

Now preparing Refer to PISCO website.

※ . Value in [] is the dimension of a "S3" spec model.

※ . ^④ : Replaced with Pad rubber material code. Refer to page 561 for details.

※ . ^⑦ : Replaced with "Q" for mark-free resin attachment.

※ . Add extra lengths below to the dimension B in the table above for dimension including a Resin attachment

Pad O.D. (mm)	σ10	σ15	σ20	σ25	σ30
Length added to dimension B (mm)	0.5	0.5	0.5	0.8	1

※ . ^⑦ : Replaced with Resin attachment material code. Refer to page 562 for details.

※ . ^⑩ : Replaced with "S3" for "Copper alloy free".

※ . Nitrile rubber (N) and Conductive NBR (Low resistance) (NE) are not suitable for measures against low ozone concentration.

※ . Bulkhead nut tightening torque

- Pad dia. : σ10 ~ σ50mm ▶ 4.5 ~ 6N·m
- Pad dia. : σ80mm ▶ 16 ~ 20N·m

VPF Spring type / Direct mount / Metric thread



RoHS compliant

Copper alloy free

Selectable

●VPF6, 8B□

●VPF10, 15B□

●VPF20~50B□

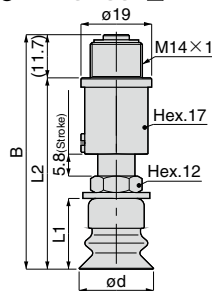
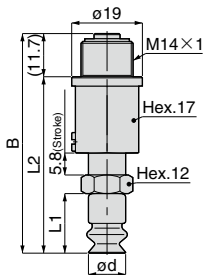
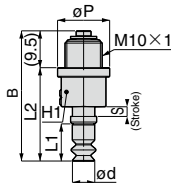

Unit : mm

Model code	Pad O.D. ød	B	L1	L2	Spring force (N)	Weight (g)	CAD file name
VPF6B ⁴ ₁₀	6	35	10	25.5	2.3~3.9	Now preparing	Refer to PISCO website.
VPF8B ⁴ ₁₀	8	35	10	25.5	2.3~3.9		
VPF10B ⁴ ₆ ⁷ ₁₀	10	59	16	47.3	7.9~15.0		
VPF15B ⁴ ₆ ⁷ ₁₀	15	59	16	47.3	7.9~15.0		
VPF20B ⁴ ₆ ⁷ ₁₀	20	63	19	51.3	7.9~15.0		
VPF25B ⁴ ₆ ⁷ ₁₀	25	63	19	51.3	7.9~15.0		
VPF30B ⁴ ₆ ⁷ ₁₀	30	67	23	55.3	7.9~15.0		
VPF40B ⁴ ₁₀	40	74	30	62.3	7.9~15.0		
VPF50B ⁴ ₁₀	50	76	32	64.3	7.9~15.0		

※ ⁴ : Replaced with Pad rubber material code. Refer to page 561 for details.

※ ₁₀ : Replaced with "-Q" for mark-free resin attachment.

※ Add extra lengths below to the dimension B in the table above for dimension including a resin attachment.

Pad O.D. (mm)	ø10	ø15	ø20	ø25	ø30
Length added to dimension B (mm)	0.5	0.5	0.5	0.8	1

※ ⁷ : Replaced with Resin attachment material code. Refer to page 562 for details.

※ ₁₀ : Replaced with "-S3" for "Copper alloy free".

※ Nitrile rubber (N) and Conductive NBR (Low resistance) (NE) are not suitable for measures against low ozone concentration.

※ Tightening torque for a fixing pad holder : 4.5~6N·m

VPA Fixed type / Top port / Barb fitting

RoHS compliant
Copper alloy free
Selectable

●VPA6、8B□

●VPA10、15B□

●VPA20~50B□

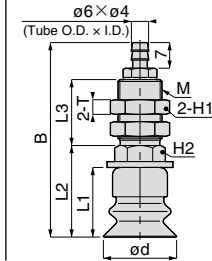
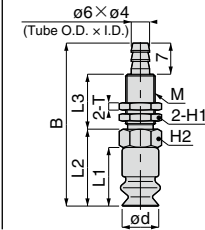
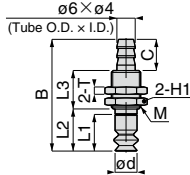

Unit : mm

Model code	Pad O.D. ød	Thread M	B	L1	L2	L3	Hex. H1	Hex. H2	T	Weight (g)	CAD file name
VPA6B ^[4] 6B ^[10]	6	M8×0.75	29	10	11.5	10.5	10	—	2	Now preparing	Refer to PISCO website.
VPA8B ^[4] 6B ^[10]	8	M8×0.75	29	10	11.5	10.5	10	—	2		
VPA10B ^[4] 6B ^[6] 7 ^[10]	10	M8×0.75	43	16	21	15	10	10	2		
VPA15B ^[4] 6B ^[6] 7 ^[10]	15	M8×0.75	43	16	21	15	10	10	2		
VPA20B ^[4] 6B ^[6] 7 ^[10]	20	M12×1	53	19	25	18	14	12	4		
VPA25B ^[4] 6B ^[6] 7 ^[10]	25	M12×1	53	19	25	18	14	12	4		
VPA30B ^[4] 6B ^[6] 7 ^[10]	30	M12×1	57	23	29	18	14	12	4		
VPA40B ^[4] 6B ^[10]	40	M12×1	64	30	36	18	14	12	4		
VPA50B ^[4] 6B ^[10]	50	M12×1	66	32	38	18	14	12	4		

※ . [4] : Replaced with Pad rubber material code. Refer to page 561 for details.

※ . [6] : Replaced with "-Q" for mark-free resin attachment.

※ . Add extra lengths below to the dimension B in the table above for dimension including a resin attachment.

Pad O.D. (mm)	ø10	ø15	ø20	ø25	ø30
Length added to dimension B (mm)	0.5	0.5	0.5	0.8	1

※ . [7] : Replaced with Resin attachment material code. Refer to page 562 for details.

※ . [10] : Replaced with "-S3" for "Copper alloy free".

※ . Nitrile rubber (N) and Conductive NBR (Low resistance) (NE) are not suitable for measures against low ozone concentration.

※ . Bulkhead nut tightening torque

- Pad dia. : ø10mm ▶ 2.5 ~ 3.5N·m. ▪ Pad dia. : ø20 ~ ø50mm ▶ 12 ~ 14N·m

VPB Fixed type / Side port / Barb fitting



RoHS compliant

Copper alloy free

Selectable



●VPB6, 8B□

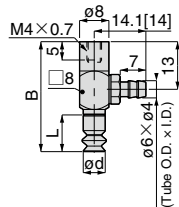

●VPB10, 15B□

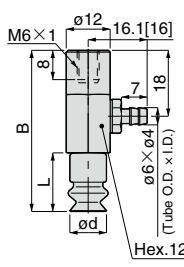

●VPB20~50B□

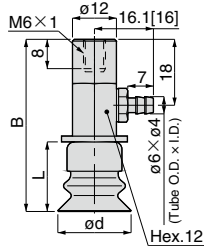

Unit : mm

Model code	Pad O.D. ød	B	L	Weight (g)	CAD file name
VPB6B ^[4] 6B ^[10]	6	30	10	Now preparing	Refer to PISCO website.
VPB8B ^[4] 6B ^[10]	8	30	10		
VPB10B ^[4] 6B ^[6] 7 ^[10]	10	44	16		
VPB15B ^[4] 6B ^[6] 7 ^[10]	15	44	16		
VPB20B ^[4] 6B ^[6] 7 ^[10]	20	47	19		
VPB25B ^[4] 6B ^[6] 7 ^[10]	25	47	19		
VPB30B ^[4] 6B ^[6] 7 ^[10]	30	51	23		
VPB40B ^[4] 6B ^[10]	40	58	30		
VPB50B ^[4] 6B ^[10]	50	60	32		

※ . Value in [] is the dimension of a "-S3" spec model.

※ . [4] : Replaced with Pad rubber material code. Refer to page 561 for details.

※ . [6] : Replaced with "-Q" for mark-free resin attachment.

※ . Add extra lengths below to the dimension B in the table above for dimension including a resin attachment.

Pad O.D. (mm)	ø10	ø15	ø20	ø25	ø30
Length added to dimension B (mm)	0.5	0.5	0.5	0.8	1

※ . [7] : Replaced with Resin attachment material code. Refer to page 562 for details.

※ . [10] : Replaced with "-S3" for "Copper alloy free".

※ . Nitrile rubber (N) and Conductive NBR (Low resistance) (NE) are not suitable for measures against low ozone concentration.



Spring type / Top port / Barb fitting



RoHS compliant

Copper alloy free
Selectable

●VPC6, 8B□

●VPC10, 15B□

●VPC20~50B□

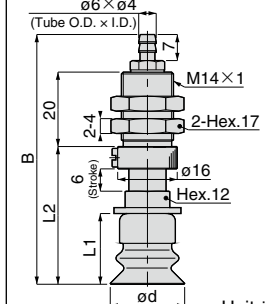
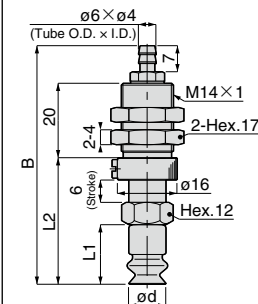
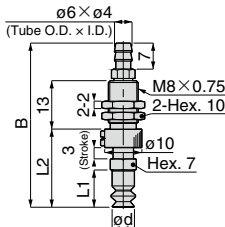

Unit : mm

Model code	Pad O.D. ød	B	L1	L2	Spring force (N)	Weight (g)	CAD file name
VPC6B ^[4] 6B ^[10]	6	44[43.9]	10	21	0.9~1.9	Now preparing	Refer to PISCO website.
VPC8B ^[4] 6B ^[10]	8	44[43.9]	10	21	0.9~1.9		
VPC10B ^[4] 6B ^[5] 7 ^[10]	10	64.1[64]	16	34	4.0~7.1		
VPC15B ^[4] 6B ^[5] 7 ^[10]	15	64.1[64]	16	34	4.0~7.1		
VPC20B ^[4] 6B ^[5] 7 ^[10]	20	67.1[67]	19	37	7.0~12.6		
VPC25B ^[4] 6B ^[5] 7 ^[10]	25	67.1[67]	19	37	7.0~12.6		
VPC30B ^[4] 6B ^[5] 7 ^[10]	30	71.1[71]	23	41	7.0~12.6		
VPC40B ^[4] 6B ^[10]	40	78.1[78]	30	48	7.0~12.6		
VPC50B ^[4] 6B ^[10]	50	80.1[80]	32	50	7.0~12.6		

- ※ . Value in [] is the dimension of a "-S3" spec model.
- ※ . [4] : Replaced with Pad rubber material code. Refer to page 561 for details.
- ※ . [5] : Replaced with "-Q" for mark-free resin attachment.
- ※ . Add extra lengths below to the dimension B in the table above for dimension including a resin attachment.

Pad O.D. (mm)	ø10	ø15	ø20	ø25	ø30
Length added to dimension B (mm)	0.5	0.5	0.5	0.8	1

- ※ . [7] : Replaced with Resin attachment material code. Refer to page 562 for details.
- ※ . [10] : Replaced with "-S3" for "Copper alloy free".
- ※ . Nitrile rubber (N) and Conductive NBR (Low resistance) (NE) are not suitable for measures against low ozone concentration.
- ※ . Bulkhead nut tightening torque : 4.5~6N·m

VACUUM PAD

580

- Bellows Series
- Multi-bellows Series
- Oval Series
- Soft Series
- Soft Bellows Series
- Skirtproof Series
- Ultrathin Series
- Flat Series
- Mark-free Series
- Long Stroke Series
- Vacuum Cylinder
- Air Pinsetter

VPD Spring type / Side port / Barb fitting



RoHS compliant

Copper alloy free

Selectable

● VPD6, 8B□

● VPD10, 15B□

● VPD20~50B□

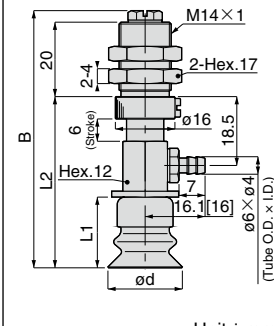
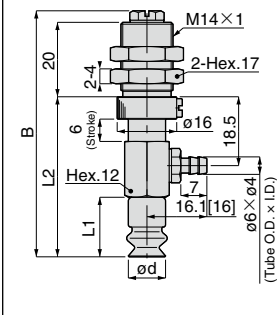
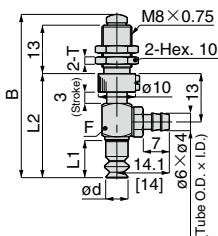

Unit : mm

Model code	Pad O.D. ød	B	L1	L2	Spring force (N)	Weight (g)	CAD file name
VPD6B[4]6B[10]	6	44[43.7]	10	28	0.9~1.9	Now preparing	Refer to PISCO website.
VPD8B[4]6B[10]	8	44[43.7]	10	28	0.9~1.9		
VPD10B[4]6B[6]7[10]	10	66.1[66]	16	43	4.0~7.1		
VPD15B[4]6B[6]7[10]	15	66.1[66]	16	43	4.0~7.1		
VPD20B[4]6B[6]7[10]	20	69.1[69]	19	46	7.0~12.6		
VPD25B[4]6B[6]7[10]	25	69.1[69]	19	46	7.0~12.6		
VPD30B[4]6B[6]7[10]	30	73.1[73]	23	50	7.0~12.6		
VPD40B[4]6B[6]7[10]	40	80.1[80]	30	57	7.0~12.6		
VPD50B[4]6B[6]7[10]	50	82.1[82]	32	59	7.0~12.6		

※. Value in [] is the dimension of a "-S3" spec model.

※. [4] : Replaced with Pad rubber material code. Refer to page 561 for details.

※. [6] : Replaced with "-Q" for mark-free resin attachment.

※. Add extra lengths below to the dimension B in the table above for dimension including a resin attachment.

Pad O.D. (mm)	ø10	ø15	ø20	ø25	ø30
Length added to dimension B (mm)	0.5	0.5	0.5	0.8	1

※. [7] : Replaced with Resin attachment material code. Refer to page 562 for details.

※. [10] : Replaced with "-S3" for "Copper alloy free".

※. Nitrile rubber (N) and Conductive NBR (Low resistance) (NE) are not suitable for measures against low ozone concentration.

※. Bulkhead nut tightening torque : 4.5 ~ 6N·m

VACUUM PAD

581

Standard Series

Sponge Series

Bellows Series

VPMA Fixed type / Top port / Push-in fitting



RoHS compliant
Copper alloy free
Selectable



●VPMA6、8B□

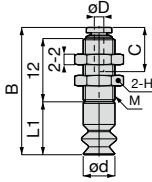

●VPMA10、15B□

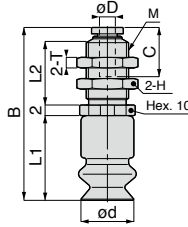

●VPMA20~30B□

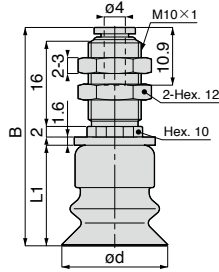

Unit : mm

Model code	Tube O.D. øD	Pad O.D. ød	Thread M	B	L1	L2	C	Hex. H	T	Weight (g)	CAD file name
VPMA6B ^[4] 180J	1.8	6	M6 × 0.75	24.1	10	—	8.4	8	2	Now preparing	Refer to PISCO website.
VPMA6B ^[4] 3J	3		M8 × 0.75	24.7	10	—	9.3	10	2		
VPMA8B ^[4] 180J	1.8	8	M6 × 0.75	24.1	10	—	8.4	8	2		
VPMA8B ^[4] 3J	3		M8 × 0.75	24.7	10	—	9.3	10	2		
VPMA10B ^[4] 3J ^[6] ^[7]	3	10	M8 × 0.75	32.7	16	12	9.3	10	2		
VPMA10B ^[4] 4J ^[6] ^[7] ^[10]	4		M10 × 1	36.7	16	16	10.9	12	3		
VPMA15B ^[4] 3J ^[6] ^[7]	3	15	M8 × 0.75	32.7	16	12	9.3	10	2		
VPMA15B ^[4] 4J ^[6] ^[7] ^[10]	4		M10 × 1	36.7	16	16	10.9	12	3		
VPMA20B ^[4] 4J ^[6] ^[7] ^[10]	—	20	—	41.3	19	—	—	—	—		
VPMA25B ^[4] 4J ^[6] ^[7] ^[10]	—	25	—	41.3	19	—	—	—	—		
VPMA30B ^[4] 4J ^[6] ^[7] ^[10]	—	30	—	45.3	23	—	—	—	—		

※ . [4] : Replaced with Pad rubber material code. Refer to page 561 for details.

※ . [6] : Replaced with "Q" for mark-free resin attachment.

※ . Add extra lengths below to the dimension B in the table above for dimension including a resin attachment.

Pad O.D. (mm)	ø10	ø15	ø20	ø25	ø30
Length added to dimension B (mm)	0.5	0.5	0.5	0.8	1

※ . [7] : Replaced with Resin attachment material code. Refer to page 562 for details.

※ . [10] : Replaced with "-S3" for "Copper alloy free". This option is not available for tube O.D. ø3mm.

※ . Nitrile rubber (N) and Conductive NBR (Low resistance) (NE) are not suitable for measures against low ozone concentration.

※ . Bulkhead nut tightening torque

- Pad dia. : ø10mm, Thread M : M8×0.75 ▶ 2.5~3.5N·m, ▪ Pad dia. : ø10mm, Thread M : M10×1 ▶ 5~7N·m,
- Pad dia. : ø20~ø30mm ▶ 5~7N·m

VPMB Fixed type / Side port / Push-in fitting



RoHS compliant

Copper alloy free
Selectable



● VPMB6, 8B□

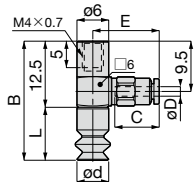

● VPMB10, 15B□

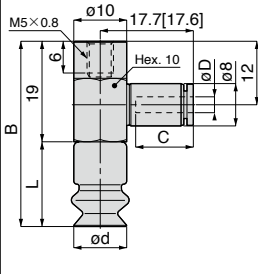

● VPMB20~30B□

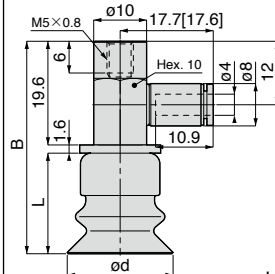

Unit : mm

Model code	Tube O.D. øD	Pad O.D. ød	B	L	E	C	Weight (g)	CAD file name
VPMB6B[4]180J	1.8	6	22.5	10	12.7[12.6]	8.4	Now preparing	Refer to PISCO website.
VPMB6B[4]3J	3							
VPMB8B[4]180J	1.8	8	22.5	10	12.7[12.6]	8.4		
VPMB8B[4]3J	3							
VPMB10B[4]3J[6]7	3	10	35	16	-	9.3		
VPMB10B[4]4J[6]7[10]	4					10.9		
VPMB15B[4]3J[6]7	3	15	35	16	-	9.3		
VPMB15B[4]4J[6]7[10]	4					10.9		
VPMB20B[4]4J[6]7[10]	-	20	40.2	19	-	-		
VPMB25B[4]4J[6]7[10]	-	25	40.2	19	-	-		
VPMB30B[4]4J[6]7[10]	-	30	44.2	23	-	-		

※ Value in [] is the dimension of a "-S3" spec model.

※ [4] : Replaced with Pad rubber material code. Refer to page 561 for details.

※ [6] : Replaced with "-Q" for mark-free resin attachment.

※ Add extra lengths below to the dimension B in the table above for dimension including a resin attachment.

Pad O.D. (mm)	ø10	ø15	ø20	ø25	ø30
Length added to dimension B (mm)	0.5	0.5	0.5	0.8	1

※ [7] : Replaced with Resin attachment material code. Refer to page 562 for details.

※ [10] : Replaced with "-S3" for "Copper alloy free". This option is not available for tube O.D. ø3mm.

※ Nitrile rubber (N) and Conductive NBR (Low resistance) (NE) are not suitable for measures against low ozone concentration.

VPMC Spring type / Top port / Push-in fitting

RoHS compliant
Copper alloy free
Selectable

New



●VPMC6, 8B□

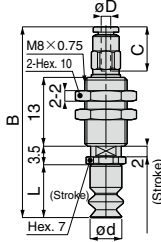

●VPMC10, 15B□

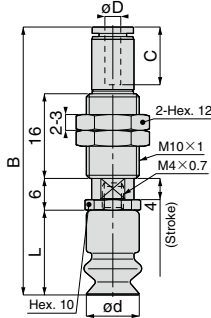

●VPMC20~30B□

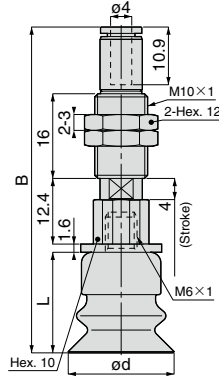

Unit : mm

Model code	Tube O.D. øD	Pad O.D. ød	B	C	L	Spring force (N)	Weight (g)	CAD file name
VPMC6B[4]180J	1.8	6	36.2[36.1]	8.4	10	0.5 ~ 0.6	Now preparing	Refer to PISCO website.
VPMC6B[4]3J	3		37.1[37]	9.3				
VPMC8B[4]180J	1.8	8	36.2[36.1]	8.4	10	0.5 ~ 0.6		
VPMC8B[4]3J	3		37.1[37]	9.3				
VPMC10B[4]3J[6]7	3	10	48.6[48.5]	9.3	16	1 ~ 1.3		
VPMC10B[4]4J[6]7[10]	4		50.7[50.6]	10.9				
VPMC15B[4]3J[6]7	3	15	48.6[48.5]	9.3	16	1 ~ 1.3		
VPMC15B[4]4J[6]7[10]	4		50.7[50.6]	10.9				
VPMC20B[4]4J[6]7[10]	—	20	61.7[61.6]	—	19	1 ~ 1.3		
VPMC25B[4]4J[6]7[10]	—	25	61.7[61.6]	—	19	1 ~ 1.3		
VPMC30B[4]4J[6]7[10]	—	30	65.7[65.6]	—	23	1 ~ 1.3		

- ※ . Value in [] is the dimension of a "-S3" spec model.
- ※ . [4] : Replaced with Pad rubber material code. Refer to page 561 for details.
- ※ . [6] : Replaced with "-Q" for mark-free resin attachment.
- ※ . Add extra lengths below to the dimension B in the table above for dimension including a resin attachment.

Pad O.D. (mm)	ø10	ø15	ø20	ø25	ø30
Length added to dimension B (mm)	0.5	0.5	0.5	0.8	1

- ※ . [7] : Replaced with Resin attachment material code. Refer to page 562 for details.
- ※ . [10] : Replaced with "-S3" for "Copper alloy free". This option is not available for tube O.D. ø3mm.
- ※ . Nitrile rubber (N) and Conductive NBR (Low resistance) (NE) are not suitable for measures against low ozone concentration.
- ※ . Bulkhead nut tightening torque : 4.5 ~ 6N·m

VPMD Spring type / Side port / Push-in fitting



RoHS compliant

Copper alloy free
Selectable

New

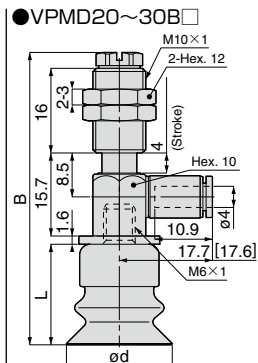
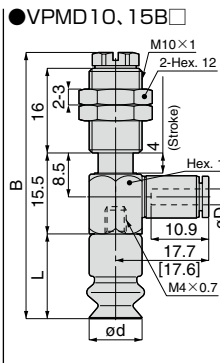
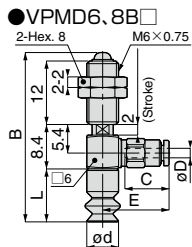

Unit : mm

Model code	Tube O.D. øD	Pad O.D. ød	B	L	E	Spring force (N)	Weight (g)	CAD file name
VPMD6B[4]180J	1.8	6	24.1	10	12.7[12.6]	0.5 ~ 0.6	Now preparing	Refer to PISCO website.
VPMD6B[4]3J	3		24.7		13.6[13.5]			
VPMD8B[4]180J	1.8	8	24.1	10	12.7[12.6]			
VPMD8B[4]3J	3		24.7		13.6[13.5]			
VPMD10B[4]3J[6]7	3	10	50.5	16	—	1 ~ 1.3		
VPMD10B[4]4J[6]7[10]	4							
VPMD15B[4]3J[6]7	3	15	32.7	16	—	1 ~ 1.3		
VPMD15B[4]4J[6]7[10]	4		36.7					
VPMD20B[4]4J[6]7[10]	—	20	55.3	19	—	1 ~ 1.3		
VPMD25B[4]4J[6]7[10]	—	25	55.3	19	—	1 ~ 1.3		
VPMD30B[4]4J[6]7[10]	—	30	59.3	23	—	1 ~ 1.3		

※. Value in [] is the dimension of a "-S3" spec model.

※. [4] : Replaced with Pad rubber material code. Refer to page 561 for details.

※. [6] : Replaced with "-Q" for mark-free resin attachment.

※. Add extra lengths below to the dimension B in the table above for dimension including a resin attachment.

Pad O.D. (mm)	ø10	ø15	ø20	ø25	ø30
Length added to dimension B (mm)	0.5	0.5	0.5	0.8	1

※. [7] : Replaced with Resin attachment material code. Refer to page 562 for details.

※. [10] : Replaced with "-S3" for "Copper alloy free". This option is not available for tube O.D. ø3mm.

※. Nitrile rubber (N) and Conductive NBR (Low resistance) (NE) are not suitable for measures against low ozone concentration.

※. Bulkhead nut tightening torque : 4.5 ~ 6N · m

VPMA Fixed type / Top port / Barb fitting



RoHS compliant
Copper alloy free
Selectable

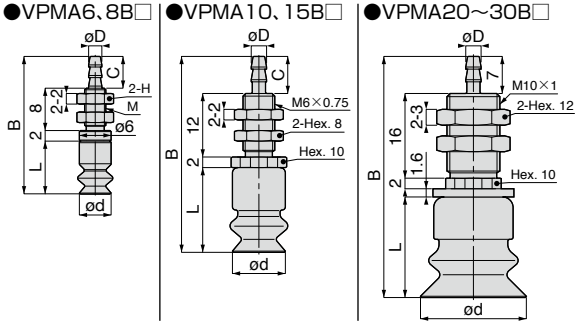

Unit : mm

Model code	Tube O.D. x I.D. ϕD	Pad O.D. ϕd	B	L	C	Weight (g)	CAD file name
VPMA6B ^[4] 3B ^[10]	3x2	6	24	10	6	Now preparing	Refer to PISCO website.
VPMA6B ^[4] 4B ^[10]	4x2.5		27		7		
VPMA8B ^[4] 3B ^[10]	3x2	8	26	10	6		
VPMA8B ^[4] 4B ^[10]	4x2.5		27		7		
VPMA10B ^[4] 3B ^[6] 7 ^[10]	3x2	10	36	16	6		
VPMA10B ^[4] 4B ^[6] 7 ^[10]	4x2.5		37		7		
VPMA15B ^[4] 3B ^[6] 7 ^[10]	3x2	15	36	16	6		
VPMA15B ^[4] 4B ^[6] 7 ^[10]	4x2.5		37		7		
VPMA20B ^[4] 4B ^[6] 7 ^[10]	4x2.5	20	45.6	19	—		
VPMA20B ^[4] 6B ^[6] 7 ^[10]	6x4		—		—		
VPMA25B ^[4] 4B ^[6] 7 ^[10]	4x2.5	25	45.6	19	—		
VPMA25B ^[4] 6B ^[6] 7 ^[10]	6x4		—		—		
VPMA30B ^[4] 4B ^[6] 7 ^[10]	4x2.5	30	49.6	23	—		
VPMA30B ^[4] 6B ^[6] 7 ^[10]	6x4		—		—		

- ※ . [4] : Replaced with Pad rubber material code. Refer to page 561 for details.
- ※ . [6] : Replaced with "-Q" for mark-free resin attachment.
- ※ . Add extra lengths below to the dimension B in the table above for dimension including a resin attachment.

Pad O.D. (mm)	$\phi 10$	$\phi 15$	$\phi 20$	$\phi 25$	$\phi 30$
Length added to dimension B (mm)	0.5	0.5	0.5	0.8	1

- ※ . [7] : Replaced with Resin attachment material code. Refer to page 562 for details.
- ※ . [10] : Replaced with "-S3" for "Copper alloy free". This option is not available for tube O.D. $\phi 3$ mm.
- ※ . Nitrile rubber (N) and Conductive NBR (Low resistance) (NE) are not suitable for measures against low ozone concentration.
- ※ . Bulkhead nut tightening torque
 - Pad dia. : $\phi 10$ mm ▶ 2~3N·m. ▪ Pad dia. : $\phi 20 \sim \phi 30$ mm ▶ 5~7N·m

VACUUM
PAD

586

- Bellows Series
- Multi-Bellows Series
- Oval Series
- Soft Bellows Series
- Soft Bellows Series
- Skirted Bellows Series
- Ultrathin Series
- Flat Series
- Mark-free Series
- Long Stroke Series
- Vacuum Cylinder
- Air Pincette

VPMB Fixed type / Side port / Barb fitting



RoHS compliant

Copper alloy free
Selectable



● VPMB6, 8B□

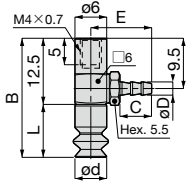

● VPMB10, 15B□

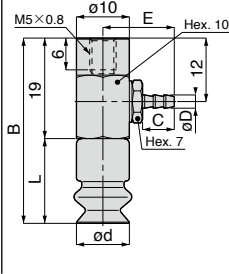

● VPMB20~30B□

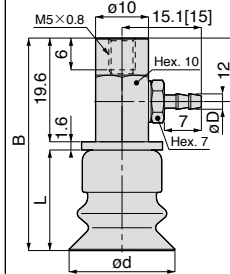

Unit : mm

Model code	Tube O.D. x I.D. øD	Pad O.D. ød	B	L	E	C	Weight (g)	CAD file name
VPMB6B□43B□10	3x2	6	22.5	10	11.6[11.5]	6	Now preparing	Refer to PISCO website.
VPMB6B□44B□10	4x2.5				12.6[12.5]	7		
VPMB8B□43B□10	3x2	8	22.5	10	11.6[11.5]	6		
VPMB8B□44B□10	4x2.5				12.6[12.5]	7		
VPMB10B□43B□6□7□10	3x2	10	35	16	13.6[13.5]	6		
VPMB10B□44B□6□7□10	4x2.5				15.1[15]	7		
VPMB15B□43B□6□7□10	3x2	15	35	16	13.6[13.5]	6		
VPMB15B□44B□6□7□10	4x2.5				15.1[15]	7		
VPMB20B□44B□6□7□10	4x2.5	20	40.2	19	-	-		
VPMB20B□46B□6□7□10	6x4				-	-		
VPMB25B□44B□6□7□10	4x2.5	25	40.2	19	-	-		
VPMB25B□46B□6□7□10	6x4				-	-		
VPMB30B□44B□6□7□10	4x2.5	30	44.2	23	-	-		
VPMB30B□46B□6□7□10	6x4				-	-		

※ Value in [] is the dimension of a "-S3" spec model.

※ [4] : Replaced with Pad rubber material code. Refer to page 561 for details.

※ [6] : Replaced with "-Q" for mark-free resin attachment.

※ Add extra lengths below to the dimension B in the table above for dimension including a resin attachment.

Pad O.D. (mm)	ø10	ø15	ø20	ø25	ø30
Length added to dimension B (mm)	0.5	0.5	0.5	0.8	1

※ [7] : Replaced with Resin attachment material code. Refer to page 562 for details.

※ [10] : Replaced with "-S3" for "Copper alloy free". This option is not available for tube O.D. ø3mm.

※ Nitrile rubber (N) and Conductive NBR (Low resistance) (NE) are not suitable for measures against low ozone concentration.

VPMC Spring type / Top port / Barb fitting

RoHS compliant

Copper alloy free
Selectable

New



●VPMC6、8B□

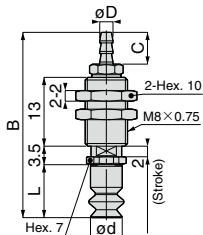

●VPMC10、15B□

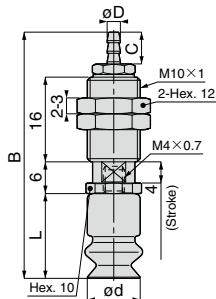

●VPMC20~30B□

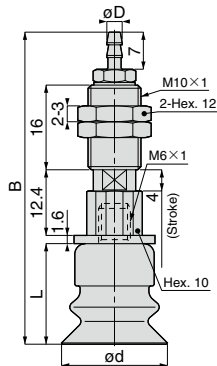

Unit : mm

Model code	Tube O.D. x I.D. øD	Pad O.D. ød	B	L	C	Spring force (N)	Weight (g)	CAD file name
VPMC6B ^[4] 3B ^[7] 10	3×2	6	35.1[35]	10	6	0.5 ~ 0.6	Now preparing	Refer to PISCO website.
VPMC6B ^[4] 4B ^[7] 10	4×2.5		36.1[36]		7			
VPMC8B ^[4] 3B ^[7] 10	3×2	8	35.1[35]	10	6	0.5 ~ 0.6		
VPMC8B ^[4] 4B ^[7] 10	4×2.5		36.1[36]		7			
VPMC10B ^[4] 3B ^[7] 10	3×2	10	46.6[46.5]	16	6	1 ~ 1.3		
VPMC10B ^[4] 4B ^[7] 10	4×2.5		48.1[48]		7			
VPMC15B ^[4] 3B ^[7] 10	3×2	15	46.6[46.5]	16	6	1 ~ 1.3		
VPMC15B ^[4] 4B ^[7] 10	4×2.5		48.1[48]		7			
VPMC20B ^[4] 4B ^[7] 10	4×2.5	20	59.1[59]	19	—	1 ~ 1.3		
VPMC20B ^[4] 6B ^[7] 10	6×4				—			
VPMC25B ^[4] 4B ^[7] 10	4×2.5	25	59.1[59]	19	—	1 ~ 1.3		
VPMC25B ^[4] 6B ^[7] 10	6×4				—			
VPMC30B ^[4] 4B ^[7] 10	4×2.5	30	63.1[63]	23	—	1 ~ 1.3		
VPMC30B ^[4] 6B ^[7] 10	6×4				—			

※ . Value in [] is the dimension of a "-S3" spec model.

※ . [4] : Replaced with Pad rubber material code. Refer to page 561 for details.

※ . [6] : Replaced with "-Q" for mark-free resin attachment.

※ . Add extra lengths below to the dimension B in the table above for dimension including a resin attachment.

Pad O.D. (mm)	ø10	ø15	ø20	ø25	ø30
Length added to dimension B (mm)	0.5	0.5	0.5	0.8	1

※ . [7] : Replaced with Resin attachment material code. Refer to page 562 for details.

※ . [10] : Replaced with "-S3" for "Copper alloy free". This option is not available for tube O.D. ø3mm.

※ . Nitrile rubber (N) and Conductive NBR (Low resistance) (NE) are not suitable for measures against low ozone concentration.

※ . Bulkhead nut tightening torque : 4 ~ 6N · m

VACUUM
PAD

588

Bellows
Series

MiniBellows
Series

Oval
Series

Soft
Bellows
Series

Self Bellows
Series

Skirted
Series

Ultrathin
Series

Flat
Series

Mark-free
Series

Long Stroke
Series

Vacuum
Cylinder

Air
Pincette

VPMD Spring type / Side port / Barb fitting



RoHS compliant

Copper alloy free
Selectable

New



●VPMD6, 8B□

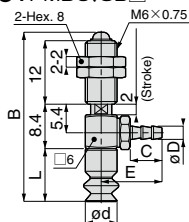

●VPMD10, 15B□

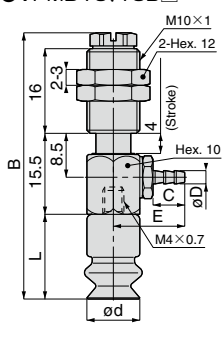

●VPMD20~30B□

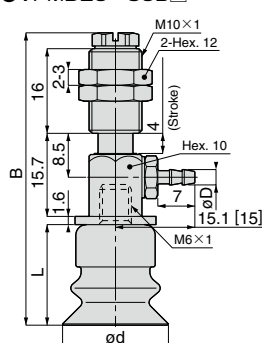

Unit : mm

Model code	Tube O.D. x I.D. øD	Pad O.D. ød	B	L	E	C	Spring force (N)	Weight (g)	CAD file name
VPMD6B ^[4] 3B ^[7] □	3×2	6	32	10	11.6[11.5]	6	0.5 ~ 0.6	Now preparing	Refer to PISCO website.
VPMD6B ^[4] 4B ^[7] □	4×2.5				12.6[12.5]	7			
VPMD8B ^[4] 3B ^[7] □	3×2	8	32	10	11.6[11.5]	6			
VPMD8B ^[4] 4B ^[7] □	4×2.5				12.6[12.5]	7			
VPMD10B ^[4] 3B ^[7] □	3×2	10	50.5	16	13.6[13.5]	6	1 ~ 1.3		
VPMD10B ^[4] 4B ^[7] □	4×2.5				15.1[15]	7			
VPMD15B ^[4] 3B ^[7] □	3×2	15	50.5	16	13.6[13.5]	6	1 ~ 1.3		
VPMD15B ^[4] 4B ^[7] □	4×2.5				15.1[15]	7			
VPMD20B ^[4] 4B ^[7] □	4×2.5	20	55.3	19	—	—	1 ~ 1.3		
VPMD20B ^[4] 6B ^[7] □	6×4				—	—			
VPMD25B ^[4] 4B ^[7] □	4×2.5	25	55.3	19	—	—	1 ~ 1.3		
VPMD25B ^[4] 6B ^[7] □	6×4				—	—			
VPMD30B ^[4] 4B ^[7] □	4×2.5	30	59.3	23	—	—	1 ~ 1.3		
VPMD30B ^[4] 6B ^[7] □	6×4				—	—			

※ . Value in [] is the dimension of a "S3" spec model.

※ [4] : Replaced with Pad rubber material code. Refer to page 561 for details.

※ [6] : Replaced with "Q" for mark-free resin attachment.

※ . Add extra lengths below to the dimension B in the table above for dimension including a resin attachment.

Pad O.D. (mm)	ø10	ø15	ø20	ø25	ø30
Length added to dimension B (mm)	0.5	0.5	0.5	0.8	1

※ [7] : Replaced with Resin attachment material code. Refer to page 562 for details.

※ [□] : Replaced with "S3" for "Copper alloy free". This option is not available for tube O.D. ø3mm.

※ . Nitrile rubber (N) and Conductive NBR (Low resistance) (NE) are not suitable for measures against low ozone concentration.

※ . Bulkhead nut tightening torque : 4 ~ 6N·m

Construction (Combinations with Standard Vacuum Pad Holder)

● Pad dia. : $\phi 6\text{mm}$, $\phi 8\text{mm}$

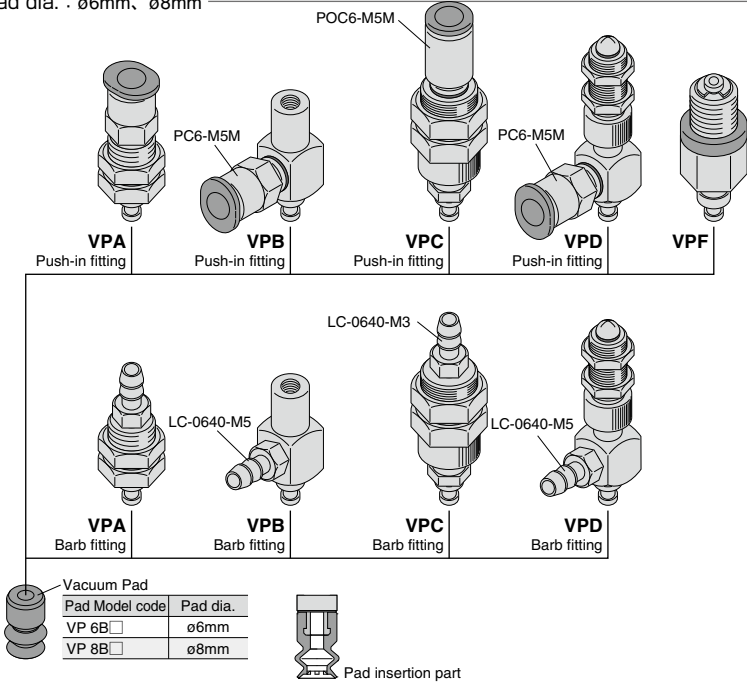

※ The Fitting model code for option "-S3" (copper alloy free and against low ozone concentration) is different from that of standard products. Contact us for details.

※ Holder alone is purchasable by the following model code.

Model code : VP①10R()6J/6B

① : Holder type

● Pad dia. : $\phi 10\text{mm}$, $\phi 15\text{mm}$

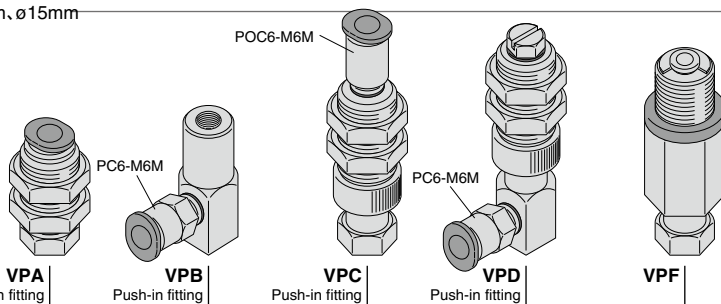

VPA
Push-in fitting

VPB
Push-in fitting

VPC
Push-in fitting

VPD
Push-in fitting

VPF

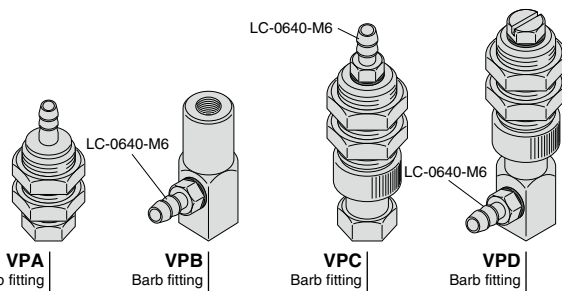

VPA
Barb fitting

VPB
Barb fitting

VPC
Barb fitting

VPD
Barb fitting

(Option)

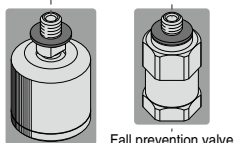

Free holder

Fall prevention valve

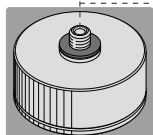

Vacuum filter pad direct mounting type

※ The Fitting model code for option "-S3" (copper alloy free and against low ozone concentration) is different from that of standard products. Contact us for details.

※ Holder alone is purchasable by the following model code.

Model code : VP①10R()6J/6B

① : Holder type

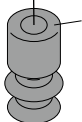

Vacuum Pad

Pad model code	Pad dia.
VP 10B□	$\phi 10\text{mm}$
VP 15B□	$\phi 15\text{mm}$



Pad screw

Pad screw model code	Pad dia.
VPM 46-6	$\phi 10\text{mm}$
	$\phi 15\text{mm}$



Resin attachment (option)

Model code	Pad dia.
VP10B□-AT	$\phi 10\text{mm}$
VP15B□-AT	$\phi 15\text{mm}$

● Pad dia. : $\phi 20\text{mm}$, $\phi 25\text{mm}$, $\phi 30\text{mm}$, $\phi 40\text{mm}$, $\phi 50\text{mm}$

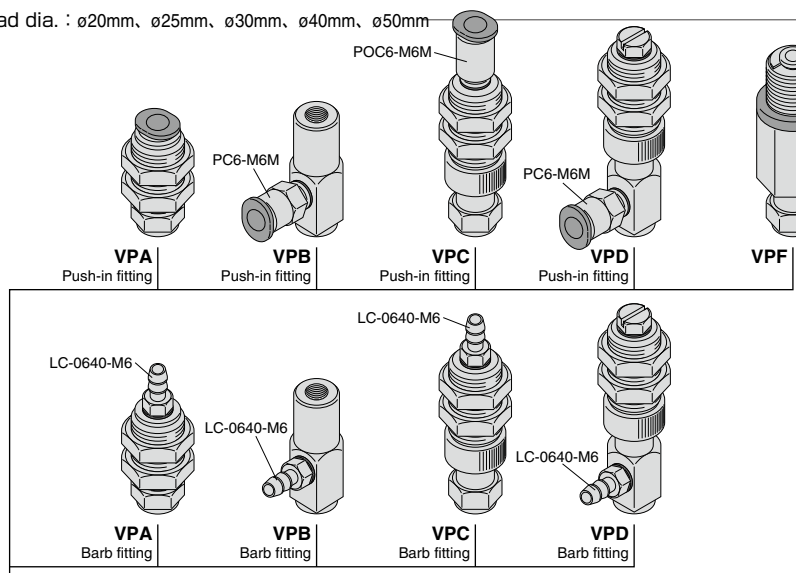

(Option)

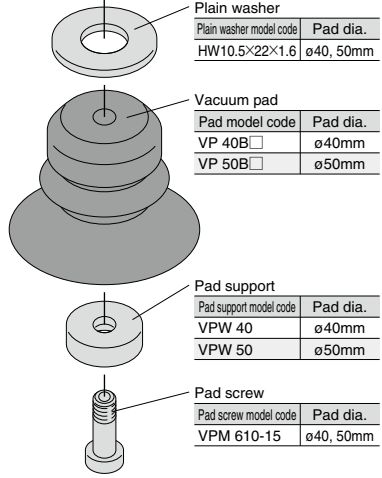
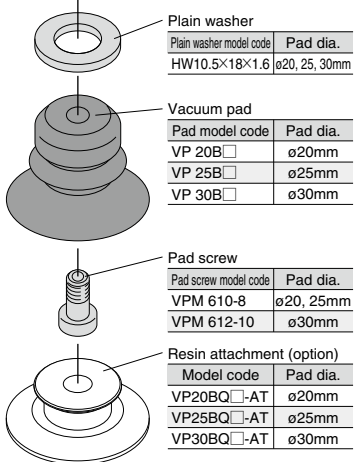
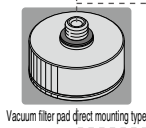
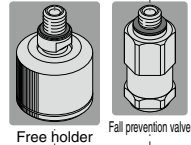

※ The Fitting model code for option "S3" (copper alloy free and against low ozone concentration) is different from that of standard products. Contact us for details.

※ Holder alone is purchasable by the following model code.

Model code : VP①②R()6J/6B
① : Holder type, ② : Pad size

● Pad dia. : ø60mm, ø80mm, ø100mm

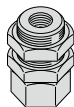

VPA

Parallel female thread

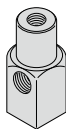

VPB

Parallel female thread

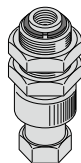

VPC

Parallel female thread

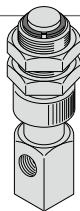

VPD

Parallel female thread

VACUUM PAD

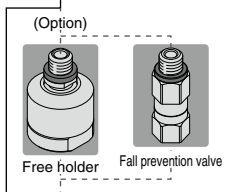

Free holder

Fall prevention valve

Plain washer

Plain washer model code	Pad dia.
HW32×17×2.6	ø60mm

Vacuum pad

Pad model code	Pad dia.
VP 60B□	ø60mm

Pad support

Pad support model code	Pad dia.
VPW 60	ø60mm

Pad screw

Pad screw model code	Pad dia.
VPM 1018	ø60mm

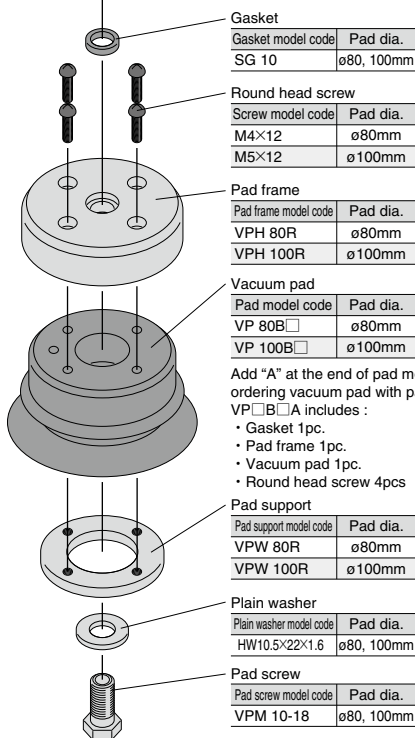

Gasket

Gasket model code	Pad dia.
SG 10	ø80, 100mm

Round head screw

Screw model code	Pad dia.
M4×12	ø80mm
M5×12	ø100mm

Pad frame

Pad frame model code	Pad dia.
VPH 80R	ø80mm
VPH 100R	ø100mm

Vacuum pad

Pad model code	Pad dia.
VP 80B□	ø80mm
VP 100B□	ø100mm

Add "A" at the end of pad model code for ordering vacuum pad with pad frame.

VP□B□A includes :

- Gasket 1pc.
- Pad frame 1pc.
- Vacuum pad 1pc.
- Round head screw 4pcs

Pad support

Pad support model code	Pad dia.
VPW 80R	ø80mm
VPW 100R	ø100mm

Plain washer

Plain washer model code	Pad dia.
HW10.5×22×1.6	ø80, 100mm

Pad screw

Pad screw model code	Pad dia.
VPM 10-18	ø80, 100mm

※ Holder alone is purchasable by the following model code.

Model code : VP①80R()01

① : Holder type

■ Construction (Combinations with Small Vacuum Pad Holder)

● Pad dia. : ø6mm, ø8mm

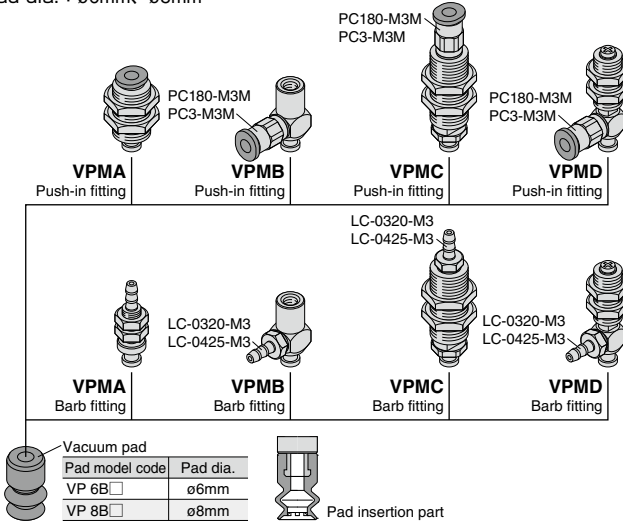

※ Barb fitting has an optional selection "-S3" (copper alloy free and against low ozone concentration). The Fitting model code for option "-S3" is different from that of standard products. Contact us for details.

※ Holder alone is purchasable by the following model code.

Model code : VPM①②R()③J/ ③B

① : Holder type, ② : Pad size, ③ : Port size

● Pad dia. : $\phi 10\text{mm}$, $\phi 15\text{mm}$



POC3-M5M
POC4-M5M

VPMA
Push-in fitting



VPMB
Push-in fitting

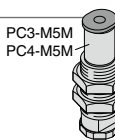

PC3-M5M
PC4-M5M

VPMC
Push-in fitting

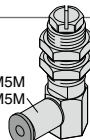

POC3-M5M
POC4-M5M

VPMD
Push-in fitting



LC-0320-M5
LC-0425-M5

VPMA
Barb fitting



VPMB
Barb fitting

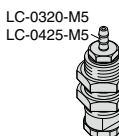

LC-0320-M5
LC-0425-M5

VPMC
Barb fitting

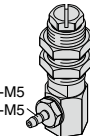

LC-0320-M5
LC-0425-M5

VPMD
Barb fitting

(Option)



Fall prevention valve

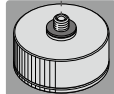

Vacuum filter pad direct mounting type

595

Standard Series

Sponge Series

Bellows Series

Vacuum Pad	
Pad model code	Pad dia.
VP 10B□	$\phi 10\text{mm}$
VP 15B□	$\phi 15\text{mm}$

Pad screw	
Pad screw model code	Pad dia.
VPM 46-6	$\phi 10\text{mm}$
	$\phi 15\text{mm}$

Resin attachment (option)	
Model code	Pad dia.
VP10BQ□-AT	$\phi 10\text{mm}$
VP15BQ□-AT	$\phi 15\text{mm}$

※ Push-in fitting ($\phi 4\text{mm}$) and Barb fitting have an optional selection "-S3" (copper alloy free and against low ozone concentration). The Fitting model code for option "-S3" is different from that of standard products. Contact us for details.

※ Holder alone is purchasable by the following model code.

Model code : VPM①10R()③J/③B

① : Holder type, ③ : Port size

● Pad dia. : $\phi 20\text{mm}$, $\phi 25\text{mm}$, $\phi 30\text{mm}$

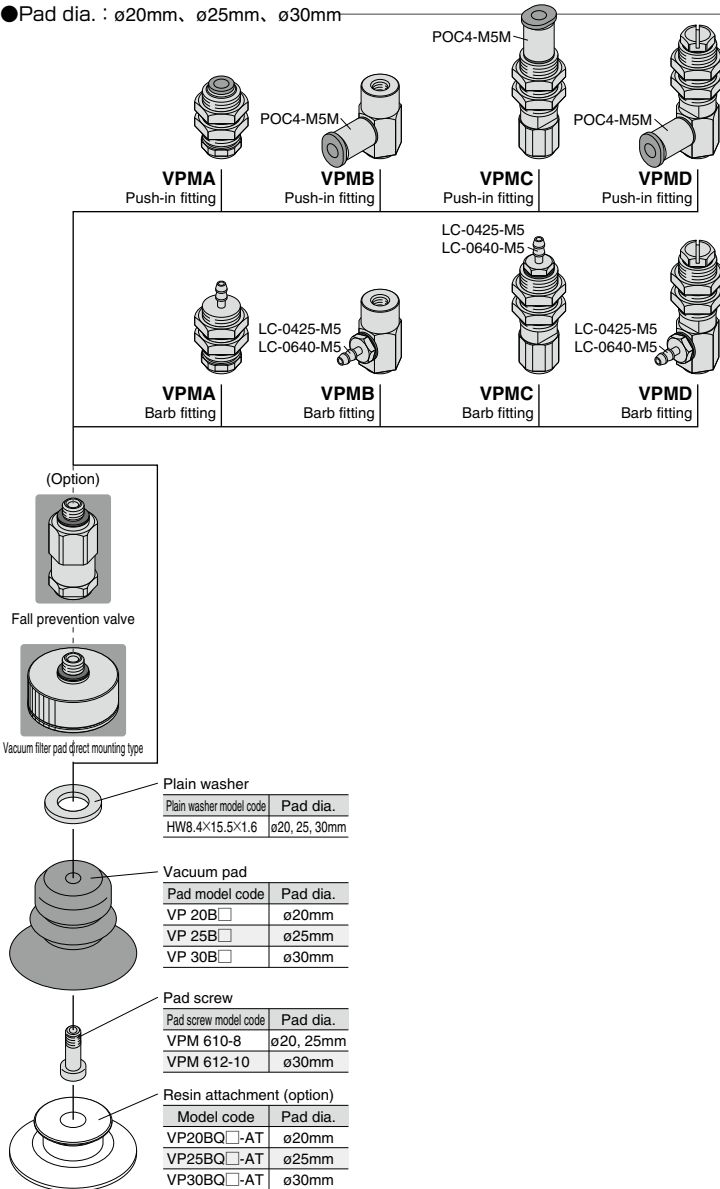

※ The Fitting model code for option "-S3" (copper alloy free and against low ozone concentration) is different from that of standard products. Contact us for details.

※ Holder alone is purchasable by the following model code.

Model code : VPM①20R()4J/③B

① : Holder type, ③ : Port size



Vacuum Pad Series

Vacuum Pad Bellows Series

VACUUM
PAD

597

Standard
Series

Sponge
Series

**Bellows
Series**

Common Safety Instructions for Vacuum Pads

Before selecting or using PISCO products, read following instructions. Read the detailed instruction for individual series as the instructions below.

Warning

1. Take safety measures in advance where a dropping work-piece can cause danger.
2. Make sure to install a vacuum pad holder securely. Looseness may cause trouble.
3. Pay special attention to the work conveyance by screwed vacuum pads, accompanied by rotary movement. There is a possibility of troubles due to the looseness of screws from the rotary movement.
4. There is a possibility of troubles due to the leakage of vacuum system, clogging, vacuum pad abrasion, crack, deterioration, the galling of slider part in the holder and the looseness in joints. Carry out maintenance inspection periodically.
5. When a work-piece is conveyed by a vacuum pad, consider the acceleration, impacts and wind pressure. Otherwise, the work-piece may drop during conveyance.

Caution

1. Thoroughly read and understand the theoretical suction force in this catalog before selecting diameter, Qty and suction place of vacuum pads. Select vacuum pads with enough margin in suction force.
2. The product incorporating NBR as seal rubber material has a risk of malfunction caused by ozone crack. Ozone exists in high concentrations in static elimination air, clean-room, and near the high-voltage motors, etc. As a countermeasure, material change from NBR to HNBR or FKM is necessary. Consult with PISCO for more information.
3. Select the material of vacuum pad in accordance with use environment and ease of use, referring to "Vacuum Pad Selection Guide".
4. Select the suitable pad shape (type) in accordance with a work-piece and its shape, referring to "Vacuum Pad Selection Guide".
5. Select spring-holder type when work-pieces have different heights or are weak against an external force. Select the suitable holder type, referring to spring force and spring length in the catalog.
6. Since spring-holder type has a sliding action, minimize the transverse load. Otherwise, the life time of the holder can be reduced or malfunction of the holder can occur.
7. In replacing vacuum pads, check the structure of holders and pads in the catalog and tighten the hexagonal-column of the holder with a proper tool, referring to the following tightening torque.

● Table. Tightening torque

Vacuum pad holder	Standard	Small
Pad screw size (mm)	Tightening torque (N·m)	
M4x0.7	0.5 ~ 1.0	0.9 ~ 1.1
M6x1	2 ~ 2.7	
M10x1.5	5 ~ 7	-
M20x2	9 ~ 10	-

8. In replacing the adapters of Soft / Soft Bellows Series, check the structure of holders, pad and adapters and tighten the hexagonal-column of the holder with a proper tool, referring to the following tightening torque.

● Table. Tightening torque

Pad screw size (mm)	Tightening torque (N·m)
M4x0.7	0.7 ~ 0.8
M6x1	1.5 ~ 2.0

9. In installing vacuum pad holders of general and small type with bulkhead, check the structure and tighten the hexagonal-column of the holder with a proper tool, referring to the following tightening torque.

Vacuum pad holder	Standard			Small		
	VPA	VPC, VPD, VPF, VPHC, VPHD, VPHDW	VPE	VPMA	VPMC, VPMD	VPME
Bulkhead nut size (mm)	Tightening torque (N·m)					
M3x0.5	—	—	0.7	—	—	0.7
M4x0.5	—	—	—	1 ~ 1.2	—	—
M4x0.7	1 ~ 1.2	—	—	—	—	—
M5x0.5	1.5 ~ 2	—	—	1.5 ~ 2	—	—
M5x0.8	—	—	1 ~ 1.5	—	—	1 ~ 1.5
M6x0.75	2 ~ 3	—	—	2 ~ 3		—
M8x0.75	2.5 ~ 3.5	1.8 ~ 2.4	—	2.5 ~ 3.5		—
M8x1	—	1.8 ~ 2.4	—	—	—	—
M10x1	5 ~ 7	4.5 ~ 6	—	5 ~ 7	4 ~ 6	—
M12x1	12 ~ 14	8 ~ 10	—	—	—	—
M14x1	18 ~ 21	4.5 ~ 6	—	—	—	—
M16x1	—	2 ~ 3	—	—	—	—
M20x1	19 ~ 21	—	—	—	—	—
M22x1	—	16 ~ 20	—	—	—	—
M24x2	40 ~ 50	—	—	—	—	—
M30x2	—	42 ~ 54	—	—	—	—

10. In replacing vacuum pad rubbers of Standard Series $\phi 80$, $\phi 100$ mm, $\phi 150$ mm, $\phi 200$ mm and Bellows Series $\phi 80$ mm, $\phi 100$ mm, check the structure of holders and pads and tighten the hexagonal-column of the holder with a proper tool, referring to the following tightening torque.

● Table. Tightening torque

Screw size (mm)	Tightening torque (N·m)
M4x0.7	0.5 ~ 0.7
M5x0.8	

- Check the structure of vacuum pad in the catalog before replacing a filter element.
- Refer to "Common Safety Instructions for Fittings" for handing fitting joint parts.
- In installing spring-holder type, do not hold the shaft **A** with a spanner. In replacing vacuum pad, hold the hexagonal-column of the shaft with a spanner. If the keyway **B** is deformed, there is a possibility of malfunction.
- Excessive tightening of a fixing nut may deform the bulkhead part and result in malfunction of the keyway.
- As the nature of rubber, powdery component like additives may come out on the surface of a vacuum pad as time elapses.

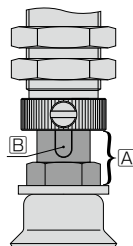

Vacuum Pad Selection Guide

Selection Guide 1 ▶ Select the diameter of vacuum pad from the formula ① and chart of the theoretical suction force ②

The theoretical suction force is determined from pad area and vacuum level. Calculated value is for reference only, so carry out the evaluation under an actual operating condition. The theoretical suction force is calculated under a static condition. Obtain an enough margin, considering the weight of a work-piece and acceleration of lifting, pause and rotary movement. Enough room is needed in deciding a number of pads and arrangement position.

① Calculation by formula

$$W = \frac{C \times P}{101} \times 10.13 \times f$$

- W : Suction force (N)
- C : Pad area (cm²)
- P : Vacuum level (-kPa)
- f : Safety factor Horizontal lifting (refer to the right fig.) ▶ 1/4
Vertical lifting (refer to the right fig.) ▶ 1/8

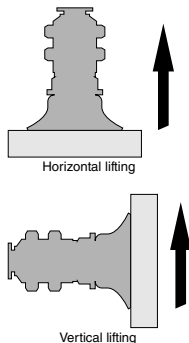

- *1. Refer to the following chart for Sponge Series (Internal diameter is used for calculation)
- *2. Refer to the following chart for Flat Series (Pad grooves are used for calculation)
- *3. As for Bellows, Multi-Bellows, Soft, Soft Bellows and Ultrathin Series, their theoretical suction force may exceed the strength of pad itself, depending on the vacuum level. Carry out the evaluation under an actual operating condition.

② Chart of the theoretical suction force (Add safety factor to values from the chart)

Standard / Bellows / Multi-bellows / Soft / Soft bellows / Skidproof / Ultrathin / Mark-free (*)

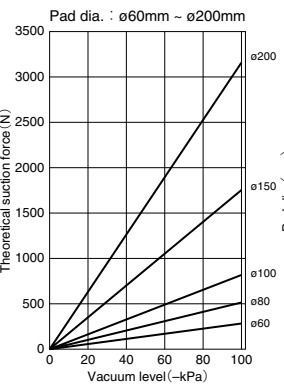
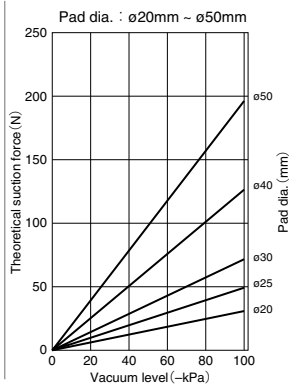
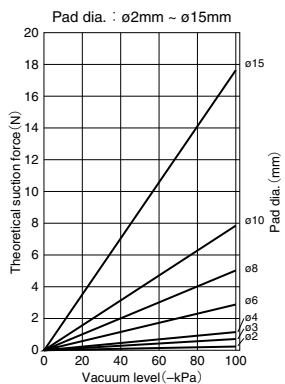
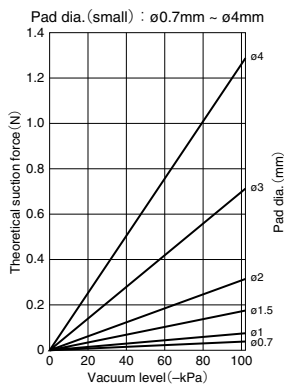

*. Some sizes are not available for some pad series. Refer to the following size list.

Pad type	Standard	Bellows	Multi-bellows	Soft	Soft bellows	Skidproof	Ultrathin	Mark-free
ø0.7-ø3	●	—	—	—	—	—	—	—
ø4	●	—	—	●	—	—	—	—
ø6	●	●	—	●	●	—	—	—
ø8	●	●	—	●	●	—	●	—
ø10	●	●	●	●	●	●	●	●
ø15	●	●	—	●	●	—	●	—
ø20	●	●	●	—	●	●	●	●
ø25	●	●	—	—	—	—	—	—
ø30	●	●	●	●	—	●	—	●
ø40	●	●	●	●	—	●	—	—
ø50	●	●	●	—	—	●	—	—
ø60	●	●	—	—	—	—	—	—
ø80	●	●	—	—	—	—	—	—
ø100	●	●	—	—	—	—	—	—
ø150	●	—	—	—	—	—	—	—
ø200	●	—	—	—	—	—	—	—

● indicates that pad size is available.

Sponge pad

Pad dia. : ϕ 10mm ~ ϕ 100mm

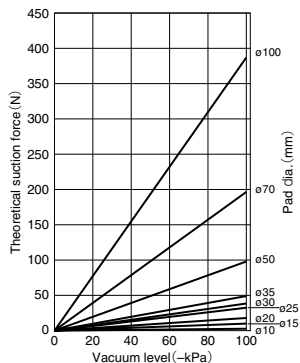

Flat pad

Pad dia. : ϕ 10mm ~ ϕ 30mm

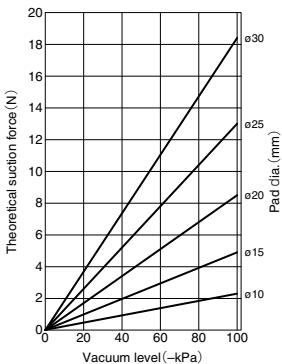

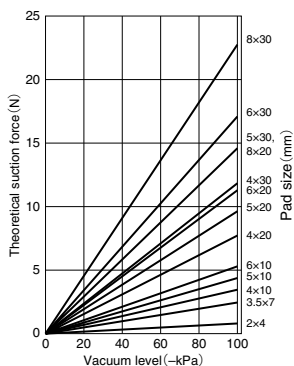

Oval pad

Pad size : 2x4mm ~ 8x30mm

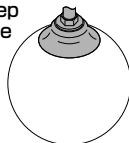

Selection Guide 2 ▶ Select a vacuum pad type according to a work-piece

Please select suitable pads for your application from the following.

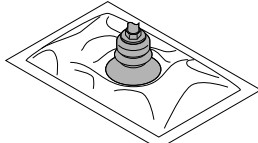
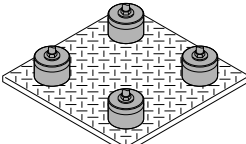
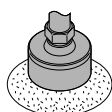
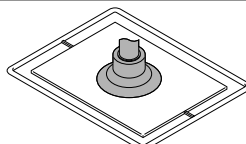
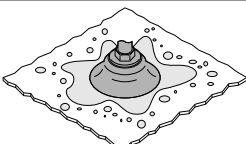
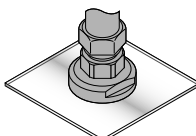
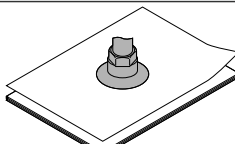
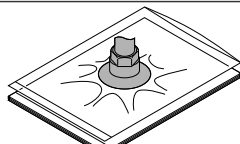
Standard Series		Bellows / Multi-bellows Series	
General type 	Deep type 	Small type 	
Thick & flat work-piece	Round fruit or ball (*1)	Small work-piece or semiconductor product	Food package
Sponge Series		Oval Series	
			
Exterior wall panel, pebble, seashell		Long work-piece (e.g. circuit board and semiconductor product)	
Soft / Soft bellows Series	Skidproof Series	Mark-free Series	
			
Molded parts / Fragile work-piece	Greasy work-piece such as pressed parts	LCD glass / in Painting process / semiconductor	
Ultrathin Series		Flat Series	
			
Thin work-piece such as paper or plastic bag		Thin work-piece such as sheet or plastic bag	

*1. The table below is a reference for the vacuum pad deep type and the size of round work-piece.

Spherical dia. : S (mm)	ø20	ø30	ø40	ø50	ø80	ø100	ø120	ø160	ø200
Pad dia. : d (mm)	ø15	ø20	ø25	ø30	ø40	ø50	ø60	ø80	ø100

*2. Refer to the previous page for pad dia. selection except deep type. Refer to the next page for the characteristics of pad materials.

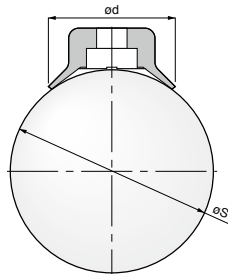

Selection Guide 3 ▶ Select a vacuum pad material from an application

Please select the suitable material from the table.

Item	Pad material	Nitrile rubber	NBR Suited for the food sanitation act. (Japan)	HNBR	Silicone rubber	Conductive Silicone rubber	Urethane rubber	Fluoro rubber	Fluorosilicone rubber	EPDM	Conductive Butadiene rubber (Low resistance type)	Conductive NBR (low resistance)	Chloroprene rubber (For Sponge type)	Silicone rubber (For Sponge Type)	
	Material code	N, NH(*1)	G	HN	S	SE	U	F	FS	EP	E	NE	-	S	
Application		Cardboard Plywood Metal plate Food-related Other general work	Cardboard Plywood Metal plate Food-related Other general work In use under a low ozone concentration environment	Semiconductors Taking out molded parts Thin work-piece Food-related	Cardboard Plywood Metal plate	Chemical environment High temp. work-pieces	Taking out molded parts	Application that requires light-resistant or ozone-proof In use under in the moisture-containing atmosphere	General parts of semiconductors	Semiconductors	Uneven work-piece	Uneven work-piece Food-related			
Pad color		Black	Gray	Black	Translucent	Black	Blue	Gray	Salmon	Black	Black	Black	Black	Salmon	
Physical Properties	Surface hardness (Shore A)	Standard	50°~80°	60°~70°	50°~70°	50°	60°	55°~70°	60°~70°	—	50°~70°	70°	60°~70°	—	—
		Bellows	50°	—	50°	50°	60°	55°	60°	—	50°	—	60°	—	—
		Multi-bellows	50°	50°	50°	50°	—	55°	50°	—	50°	—	60°	—	—
		Oval	40°~50°	—	50°	40°~50°	50°~60°	55°(*2)	50°(*2)	—	50°	70°	70°	—	—
		Soft	40°	—	—	40°	60°	—	—	40°	—	—	50°	—	—
		Soft bellows	40°	—	50°	40°	—	55°	—	—	50°	—	60°	—	—
		Skidproof	50°	—	—	50°	—	55°	60°	—	—	—	60°	—	—
	Oil resistance (Benzene/toluene)	Ultrathin	40°	—	—	40°	—	55°	50°	40°	—	—	60°	—	—
		Flat	60°	—	—	40°	40°	50°	50°	—	—	—	60°	—	—
	Highest operating temp.		110°C	140°C	180°C	180°C	60°C	230°C	180°C	150°C	100°C	110°C	80°C	180°C	
	Lowest operating temp.		-30°C	-30°C	-40°C	-40°C	-20°C	-10°C	-50°C	-40°C	-50°C	-30°C	-45°C	-40°C	
	Weatherability		△	○	◎	◎	◎	◎	◎	◎	◎	△	○	◎	
	Ozone-proof		×	○	◎	◎	◎	◎	◎	◎	×	×	○	◎	
	Acid-resistance		△	△	○	×	◎	○	◎	△	△	△	△	○	
Alkaline-resistance		○	○	◎	◎	×	×	◎	◎	○	○	◎	◎		
Volume resistance	(Gasoline oil)	△	◎	△	△	◎	◎	△	×	×	◎	×	△		
	(Benzene/toluene)	△	×	△	△	◎	△	△	×	×	△	△	△		
Volume resistance		—	—	—	Max.10 ¹² Ω·cm	—	—	—	—	—	Max.2000·cm	Max.2000·cm	—	—	

Legend ◎ : Best
○ : Suitable
△ : Good
× : NG

*1. Material code "NH" is only applicable to Skidproof Series.

*2. It does not apply to pad size: 4×30mm.

Note 1) The above "Physical Properties" shows the data of general synthetic rubbers.

Note 2) The highest / lowest operating temp. are for momentary usage. Carry out durability evaluation in case of continuous usage under the highest / lowest operating temp.

Please select the suitable vacuum pad resin material from the table.

Item	Pad material		PEEK	POM	Conductive PEEK
	Material code	Mark free series	K	M	KE
		Resin attachment for Bellows series	-QK	-QM	-QKE
Application			Semiconductor/ Manufacturing machine for liquid crystal	General production line Food-related machine Packaging machine	Semiconductors/ Manufacturing machine for liquid crystal Electronic components
Pad color			Natural (ivory)	White	Black
Physical Properties		Highest operating temp.	250°C	95°C	250°C
		Lowest operating temp.	-50°C	-60°C	-50°C
		Weatherability	⊙	×	⊙
		Acid-resistance	⊙	×	⊙
		Alkaline-resistance	⊙	△	⊙
		Self-lubricity	○	⊙	○
		Abrasion-resistance	⊙	⊙	⊙
		Volume resistance	—	—	10 ⁵ –10 ⁶ Ω·cm

- Legend
- ⊙ : Best
 - : Suitable
 - △ : Good
 - × : NG

Note 1) The above "Physical Properties" shows the data of pad resin material only. The holder of Mark-free Series is not included.

Note 2) The above "Physical Properties" shows the data of resin attachment only. The pad rubber is not included.

Note 3) The above "Physical Properties" shows general properties of resin materials and not a guaranteed value. Carry out the necessary evaluation under an actual operating condition.

Note 4) The highest / lowest operating temp. is for momentary usage. Carry out durability evaluation in case of continuous usage under the highest / lowest operating temp.

Note 5) Volume resistance is a representative value from the material manufacture, and not a guaranteed value.

To prevent dust from getting into the pad holder.

Install a vacuum filter pad direct mounting type between a vacuum pad and a holder.

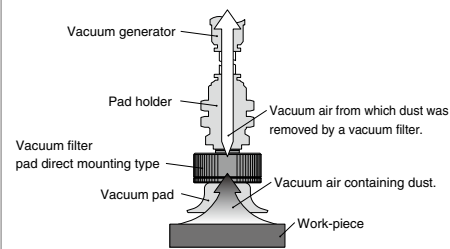

To operate several vacuum pads by single vacuum source.

Installing a fall prevention valve between a vacuum pad and a holder prevents the troubles like system break down, minimizing the vacuum drop of the whole system automatically by reducing suction flow of the part where the work-piece falls from the vacuum pad (within the range not causing any problem), or no work-piece is to be sucked.

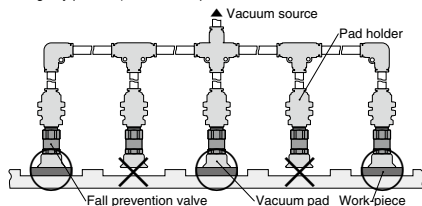

Reference Guide for Vacuum Pad

Impact on pad

Avoid an impact or a large force on a vacuum pad, when it is pressed against a work-piece. It may cause deformation, crack or abrasion at an early stage of use. Adjust the pad position so that the lip of pad touches lightly on a work-piece. Especially a small type of vacuum pad should be positioned precisely.

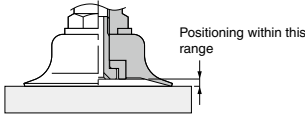

Porous or perforated work-piece

Since the suction of a porous work-piece causes a drop of suction force, select the proper specifications of vacuum system and secure a larger effective cross-section area of the piping. Selecting a small type of vacuum pad is one of solutions to reduce the air leakage.

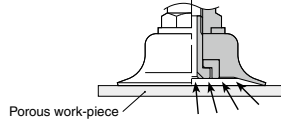

Large and wide flat plate work-piece

When lifting large size of glass board or circuit board, work-piece may bend by the lifting acceleration or the self-weight. Select a proper size of pad and positioning, considering an enough margin of suction force.

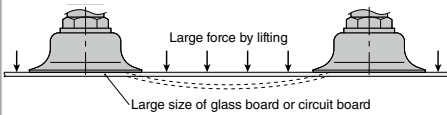

Lifting work-piece, sucking the both side of it

Since all vacuum pad holders are designed for horizontal lifting, consider the strength of holders and pads.

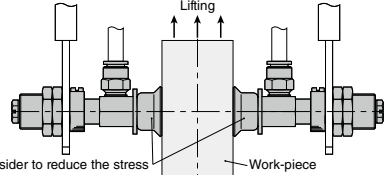

Consider to reduce the stress against holders and pads by sucking the both sides of work-piece.

Soft work-piece

When soft work-pieces such as plastic bags, papers or thin boards are sucked, work-pieces can be deformed or shrunk by vacuum suction (Figure-1). Select smaller vacuum pads and reduce the vacuum pressure. Smaller vacuum pads are suitable for plastic bags and papers. When plastic / paper bags are opened by using vacuum pads, shift the center of two vacuum pads slightly in order to open them easily as Figure-2 shows.

● Figure-1

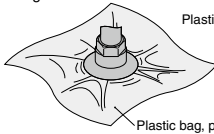

● Figure-2

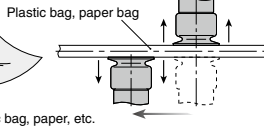

Work-piece with different heights

Select Long Stroke Series for work-pieces having different heights, or piled-up work-pieces. Its stroke can absorb the difference in height.

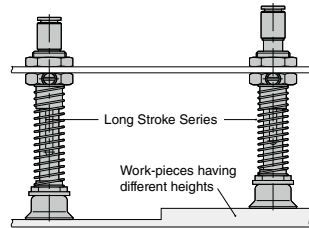

Inclined work-piece

Select Free Holder for an inclined work-piece.

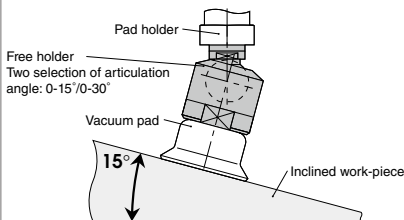

Conveyance with rotary movement

When vacuum pad is fixed with a screw and has a rotary movement, the pad may drop due to the loosened screw. Pay special attention when the vacuum location of work-piece is off the center of work-piece gravity.

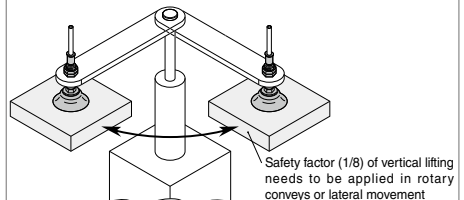

VACUUM PAD ACCESSORIES

484

- Standard Series
- Sponge Series
- Bellows Series
- Multibellows Series
- Dual Series
- Soft Series
- Soft Bellows Series
- Skinroof Series
- Ultrathin Series
- Flat Series
- Mark-free Series
- Long Stroke Series
- Vacuum Cylinder
- Air Pincette



Vacuum Pad

■ Pad dia. list by pad type and material

Pad material		N : Nitrile rubber								
Pad type	Standard			Bellows	Multi-Bellows	Soft	Soft bellows	Ultrathin	Flat	
	General type	Deep type	Small type							
Pad dia. (mm)	ø0.7			●						
	ø1	●		●						
	ø1.5			●						
	ø2	●		●						
	ø3	●		●						
	ø4	●		●			●			
	ø6	●			●		●	●		
	ø8	●			●		●	●	●	
	ø10	●			●	●	●	●	●	
	ø15	●	●		●	●	●	●	●	
	ø20	●	●		●	●	●	●	●	
	ø25	●	●		●				●	
	ø30	●	●		●	●	●		●	
	ø40	●	●		●	●	●			
	ø50	●	●		●	●				
	ø60	●	●		●					
	ø80	●	●		●					
	ø100	●	●		●					
ø150	●									
ø200	●									

※ ● : available

Pad material		S : Silicone rubber									
Pad type	Standard			Bellows	Multi-Bellows	Soft	Soft bellows	Flat	Skidproof	Ultrathin	Sponge
	General type	Deep type	Small type								
Pad dia. (mm)	ø0.7			●							
	ø1	●		●							
	ø1.5			●							
	ø2	●		●							
	ø3	●		●							
	ø4	●		●			●				
	ø6	●			●		●				
	ø8	●			●		●			●	
	ø10	●			●	●	●	●	●	●	●
	ø15	●	●		●	●	●	●	●	●	●
	ø20	●	●		●	●	●	●	●	●	●
	ø25	●	●		●				●		●
	ø30	●	●		●	●	●		●		●
	ø35										●
	ø40	●	●		●	●	●		●		
	ø50	●	●		●	●			●		●
	ø60	●	●		●						
	ø70										●
ø80	●	●		●							
ø100	●	●		●						●	
ø150	●										
ø200	●										

※ ● : available

Pad material		U : Urethane rubber								
Pad type	Standard			Bellows	Multi-Bellows	Soft bellows	Skidproof	Ultrathin	Flat	
	General type	Deep type	Small type							
Pad dia. (mm)	ø0.7			●						
	ø1	●		●						
	ø1.5			●						
	ø2	●		●						
	ø3	●		●						
	ø4	●		●						
	ø6	●			●		●			
	ø8	●			●		●		●	
	ø10	●			●	●	●	●	●	
	ø15	●	●		●		●		●	
	ø20	●	●		●	●	●	●	●	
	ø25	●	●		●				●	
	ø30	●	●		●	●			●	
	ø40	●	●		●	●		●		
	ø50	●	●		●	●		●		
	ø60	●	●		●					
	ø80	●	●		●					
ø100	●	●		●						
ø150	●									
ø200	●									

※ ● : available

Pad material		F : Fluoro rubber						G : NBR Suited for the food sanitation act. (Japan)					
Pad type	Standard			Bellows	Multi-Bellows	Skidproof	Ultrathin	Flat	Standard			Multi-Bellows	
	General type	Deep type	Small type						General type	Deep type	Small type		
Pad dia. (mm)	ø0.7			●								●	
	ø1	●		●					●			●	
	ø1.5			●								●	
	ø2	●		●					●			●	
	ø3	●		●					●			●	
	ø4	●		●					●			●	
	ø6	●			●				●				
	ø8	●			●			●	●				
	ø10	●			●	●	●	●	●				●
	ø15	●	●		●			●	●	●	●		
	ø20	●	●		●	●	●	●	●	●	●		●
	ø25	●	●		●				●	●	●		
	ø30	●	●		●	●	●	●	●	●	●		●
	ø40	●	●		●	●	●		●	●	●		●
	ø50	●	●		●	●	●		●	●	●		●
	ø60	●	●		●								
	ø80	●	●		●								
ø100	●	●		●									
ø150	●												
ø200	●												

※ ● : available



Vacuum Pad

VACUUM PAD

Pad material	SE : Conductive Silicone rubber					E : Conductive Butadiene rubber (Low resistance type)	S : Chloroprene rubber	NH : Oilproof NBR		
	Standard		Bellows	Soft	Flat				Standard	
	General type	Small type							General type	Small type
Pad dia. (mm)	ø0.7		●							
	ø1	●	●							
	ø1.5		●							
	ø2	●	●				●	●		
	ø3	●	●				●	●		
	ø4	●	●		●		●	●		
	ø6	●		●	●		●			
	ø8	●		●	●		●			
	ø10	●		●	●	●	●		●	
	ø15	●		●	●	●	●	●		
	ø20	●		●	●	●	●	●	●	
	ø25	●		●	●	●	●	●		
	ø30	●		●	●	●	●	●	●	
	ø35							●		
	ø40	●		●	●		●		●	
	ø50	●		●			●	●	●	
	ø60	●		●						
	ø70							●		
ø80	●		●							
ø100	●		●				●			
ø150	●									
ø200	●									

※ ● : available

487

Pad material	NE : Conductive NBR (low resistance)										
	Pad type	Standard			Bellows	Multi-Bellows	Soft	Soft bellows	Skidproof	Ultrathin	Flat
		General type	Deep type	Small type							
Pad dia. (mm)	ø0.7			●							
	ø1	●		●							
	ø1.5			●							
	ø2	●		●							
	ø3	●		●							
	ø4	●		●			●				
	ø6	●			●		●	●			
	ø8	●			●		●	●		●	
	ø10	●			●	●	●	●	●	●	●
	ø15	●	●		●		●	●		●	●
	ø20	●	●		●	●	●	●	●	●	●
	ø25	●	●		●						●
	ø30	●	●		●	●	●		●		●
	ø40	●	●		●	●	●		●		
	ø50	●	●		●	●			●		
	ø60	●	●		●						
	ø80	●			●						
	ø100	●	●		●						
ø150	●										
ø200	●										

※ ● : available

Pad material		HN : HNBR					EP : EPDM					FS : Fluorosilicone rubber		
		Standard			Bellows	Multi-Bellows	Soft bellows	Standard			Bellows	Multi-Bellows	Soft bellows	Soft
Pad type		General type	Deep type	Small type				General type	Deep type	Small type				
Pad dia. (mm)	ø0.7			●				●						
	ø1	●		●				●						
	ø1.5			●										
	ø2	●		●				●						
	ø3	●		●				●						
	ø4	●		●				●					●	
	ø6	●			●			●		●		●	●	
	ø8	●			●			●		●		●	●	●
	ø10	●			●	●		●		●		●	●	●
	ø15	●	●		●	●		●	●	●	●	●	●	●
	ø20	●	●		●	●		●	●	●	●	●	●	●
	ø25	●	●		●			●	●	●				
	ø30	●	●		●	●		●	●	●	●			
	ø40	●	●		●	●		●	●	●	●		●	
	ø50	●	●		●	●		●	●	●	●			
	ø60	●	●		●			●	●	●				
	ø80	●	●		●			●	●	●				
ø100	●	●		●			●	●	●					
ø150	●						●							
ø200	●						●							

※ ● : available

Pad material	N	S	U	F	SE	E	NE	HN	EP
	Nitrile rubber	Silicone rubber	Urethane rubber	Fluoro rubber	Conductive Silicone rubber	Conductive Butadiene rubber (Low resistance type)	Chloroprene rubber	HN HNBR	EP EPDM
Pad type	Oval								
Pad size (mm)	2x4	●	●	●	●	●		●	●
	3.5x7	●	●	●	●	●		●	●
	4x10	●	●	●	●	●	●	●	●
	4x20	●	●	●	●	●	●	●	●
	4x30	●	●			●	●	●	●
	5x10	●	●	●	●	●	●	●	●
	5x20	●	●	●	●	●	●	●	●
	5x30	●	●	●	●	●	●	●	●
	6x10	●	●	●	●	●	●	●	●
	6x20	●	●	●	●	●	●	●	●
6x30	●	●	●	●	●	●	●	●	
8x20	●	●	●	●	●	●	●	●	
8x30	●	●	●	●	●	●	●	●	

※ ● : available

Pad material	K : PEEK	M : POM	KE : Conductive PEEK	G2K : PEEK	G2M : POM	G2KE : Conductive PEEK
	Mark free			Resin attachment for Bellows series		
Pad size (mm)	ø10	●	●	●	●	●
	ø15					
	ø20	●	●	●	●	●
	ø25					
	ø30	●	●	●	●	●

※ ● : available

Vacuum Pad

Construction (VPA holder : Fixed type / Top port)

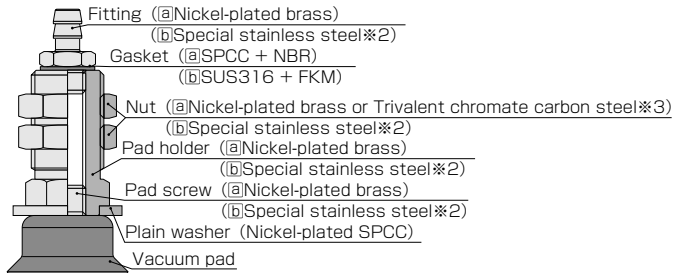

Construction (VPC holder : Spring type / Top port)

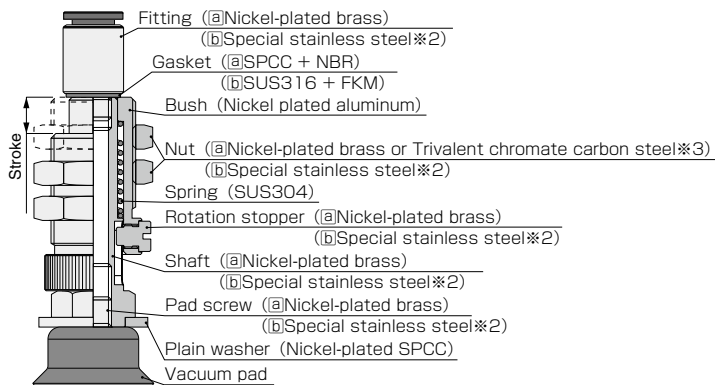

- ※ 1. a : Standard spec. b : "-S3" spec.
- ※ 2. Equivalent Corrosion Resistance to SUS303
- ※ 3. Nut material differs depending on the bulkhead thread size.

Bulkhead thread size (mm)	Nut material	
	Nickel-plated brass	Trivalent chromate carbon steel
M5×0.5	○	—
M6×0.75	○	—
M8×0.75	○	—
M10×1	○	—
M12×1	—	○
M14×1	—	○
M16×1	—	○
M20×1	—	○
M22×1	—	○
M24×2	○	—
M30×2	○	—



Safety Instructions

This Safety Instructions aim to prevent personal injury and damage to properties by requiring proper use of PISCO products.

Be certain to follow ISO 4414 and JIS B 8370.

ISO 4414 : Pneumatic fluid power...General rules and safety requirements for system and their components.

JIS B 8370 : General rules and safety requirements for systems and their components.

This Safety instructions are classified into "Danger", "Warning" and "Caution", depending on the degree of danger or damages caused by improper use of PISCO products.



Danger

Hazardous conditions. It can cause death or serious personal injury.



Warning

Hazardous conditions depending on usages. Improper Use of PISCO products can cause death or serious personal injury.



Caution

Hazardous conditions depending on usages. Improper use of PISCO products can cause personal injury or damages to properties.

Danger

1. Do not use PISCO products for the following applications.
 - ①. Equipment used for maintaining / handling human life and body.
 - ②. Equipment used for moving / transporting human.
 - ③. Equipment specifically used for safety purposes.

Warning

1. Selection of pneumatic products.
 - ① A user who is a pneumatic system designer or has sufficient experience and technical expertise should select PISCO products.
 - ② Due to wide variety of operating conditions and applications for PISCO products, carry out the analysis and evaluation on PISCO products. The pneumatic system designer is solely responsible for assuring that the user's requirements are met and that the application presents no health or safety hazards. All designers are required to fully understand the specifications of PISCO products and constitute all systems based on the latest catalog or information, considering any malfunction.
2. Usage environment

Do not use PISCO products under the following conditions.

 - ①. Beyond the specifications or conditions stated in the catalog, or the instructions.
 - ②. Use at outdoors.
 - ③. Excessive vibrations and impacts.
 - ④. Exposure / adhere to corrosive gas, flammable gas, chemicals, seawater, water and vapor.

3. Handling of product

- ①. The pneumatic equipments shall be handled by a person having enough knowledge and experiences. Improper use of compressed air is dangerous. Assembly, operation and maintenance of machines using pneumatic equipment should be conducted by a person with enough knowledge and experience.
- ②. Do not operate machine / equipment or remove pneumatic equipment until safety is confirmed.
 - (1). Make sure that preventive measures against falling work-pieces or sudden movements of machine are completed before inspection or maintenance of these machine.
 - (2). Make sure the above preventive measures are completed. A compressed air supply and the power supply to the machine must be off, and also the compressed air in the systems must be exhausted.
 - (3). Restart the machines with care after ensuring to take all preventive measures against sudden movements.
- ③. Do not disassemble or modify PISCO products, which affect the performance, function, and basic structure of the product.
- ④. Take safety measures such as providing a protection cover if there is a risk of causing damages or fire on machine / facilities by a fluid leakage.
- ⑤. Do not touch the release-ring of push-in fitting when there is a working pressure.
- ⑥. Frequent switchover of compressed air may generate heat, and there is a risk of causing burn injury.
- ⑦. Avoid any load on PISCO products, such as, a tensile strength, twisting and bending. Otherwise, there is a risk of causing damage to the products.
- ⑧. Do not use PISCO products for applications where threads or tubes swing / rotate. The product can be damaged in these applications.
- ⑨. Do not force the product to rotate or swing even its resin body is rotatable. It may cause damage to the product and a fluid leakage.
- ⑩. Do not supply excessively dry air to products. It may cause malfunction due to a deterioration of rubber parts.
- ⑪. Do not wash or paint products with water or solvent. Solvent may damage a resin body, or painting may cause malfunction.
- ⑫. The product incorporating NBR as seal rubber material has a risk of malfunction caused by ozone crack. Ozone exists in high concentrations in static elimination air, clean-room, and near the high-voltage motors, etc. As a countermeasure, material change from NBR to HNBR or FKM is necessary. Consult with PISCO for more information.
- ⑬. Do not stand on a product, or put anything on it. It may cause falls, personal injury or damage to the product.

Warranty

When the product produces a trouble, which is caused by our responsibility, we will carry out either one of the following measures immediately.

- ①. Free-of-charge replacement of same product
- ②. Free-of-charge repair of the product at our factory

Disclaimer

1. PISCO does not take any responsibility for any incidental or indirect loss, such as production line stop, interruption of business, loss of benefits, personal injury, etc., caused by any failure on use or application of PISCO products.
2. When a cause of the trouble/malfunction applies to any of the following items, it is excluded from the coverage of the above warranty.
 - ①. A case by a natural disaster, a fire except our responsibility, the act by the third person/party, the intention or fault of the customer.
 - ②. A case when a product is used out of the specific range or the method listed in the product catalog or the instruction manual.
 - ③. A case by the remodeling of the product or by a change of structure, performance, or specifications which PISCO does not involved in.
 - ④. A case by the event that is unpredictable by the evaluations and the measures at the time on or before the initial delivery.
 - ⑤. A case caused by the phenomenon that is able to be evaded if your machine or equipment has functions or structures that are comprised in a common sense when this product is incorporated in your machine or equipment.
3. The damages caused by the defect of PISCO products shall be covered but limited to the full amount of the PISCO products paid by the customer. Additionally, the above warranty is limited simply to the product itself. The damage induced by the trouble of the product will not be compensated.



Common Safety Instructions for Products Listed in This Catalog

⚠ Caution

1. An odd noise may be heard when supply pressures are immediately before the peak of vacuum levels. The sounding of this odd noise means the characteristics are unstable and the sound may become even noisier. This situation can also adversely affect the sensor, resulting in a malfunction or trouble. So reset the supply pressure.
 - ※. Pressure range in which odd noise occurs is affected by atmospheric pressure.
2. Piping design and equipment selection should be made with an effective sectional area on supply pressure side of a vacuum generator being 3 times as large as the nozzle diameter as a standard. Insufficient air flow may impair the performance of the product.
3. Do not use a lubricator on products.
4. Clean or replace silencer element periodically. There is a possibility of dropping the performance or causing troubles by clogging on the element.
5. Keep products away from water, oil drops or dusts because they are neither drip-proof nor dust-proof. Otherwise there is a possibility of causing malfunction, damage to the products, or dropping the performance.
6. Piping
 - ①. Compressed air contains a volume of drain (water, oxidized oil and foreign material, etc.) Because the drain reduce product performance remarkably, dehumidify air with an aftercooler and a dryer, and improve the air quality.
 - ②. Do not use a lubricator on products.
 - ③. Rust in pipe and inflow of foreign substances cause the trouble, malfunction, and degradation of the product. Please install a filter (5 μ m or better filtration) in the compressed air supply line right in front of the product. The flushing inside the pipe before use and in certain intervals is recommended.
 - ④. Remove dusts or drain before piping. They may get into the peripheral machine / facilities and cause malfunction.
 - ⑤. When inserting an ultra-soft tube into push-in fitting, make sure to place an Insert Ring into the tube edge. There is a risk of causing the escape of tube and a fluid leakage without using an Insert Ring.
 - ⑥. Arrange piping avoiding any load on fittings and tubes such as twist, tensile, moment load, shaking and physical impact. These may cause damages to fittings, tube deformations, bursting and the escape of tubes.
 - ⑦. Install protective cover when using at a place getting the direct sunlight.
 - ⑧. Be sure to confirm each port of a vacuum generator with its appearance drawing or the marking on it before piping. Incorrect piping has a risk of damaging the product.
 - ⑨. Plumb a pressure sensor and a vacuum generator with pressure sensor at the end of vacuum system as much as possible. A long distance between a pressure sensor and a vacuum system end may increase plumbing resistance which may lead to a high vacuum level at the sensor even when no suctioning and a malfunction of pressure sensor. Make sure to evaluate the products in an actual system.

- ⑩. A Shorter distance of plumbing with a wider bore is preferable at vacuum system side. A long plumbing with a small bore may result in slow response time at the time of releasing work-piece as well as in failure to secure adequate suction flow rate.
- ⑪. In case of using non-PISCO brand tubes, make sure the tolerance of the outer tube diameter is within the limits of Table 1.

● Table 1. Tube O.D. Tolerance

mm size	Nylon tube	Polyurethane tube	inch size	Nylon tube	Polyurethane tube
ø1.8mm	—	±0.05mm	ø1/8	±0.1mm	±0.15mm
ø2mm	—	±0.05mm	ø5/32	±0.1mm	±0.15mm
ø3mm	—	±0.15mm	ø3/16	±0.1mm	±0.15mm
ø4mm	±0.1mm	±0.15mm	ø1/4	±0.1mm	±0.15mm
ø6mm	±0.1mm	±0.15mm	ø5/16	±0.1mm	±0.15mm
ø8mm	±0.1mm	±0.15mm	ø3/8	±0.1mm	±0.15mm
ø10mm	±0.1mm	±0.15mm	ø1/2	±0.1mm	±0.15mm
ø12mm	±0.1mm	±0.15mm	ø5/8	±0.1mm	±0.15mm
ø16mm	±0.1mm	±0.15mm			

7-1. Tube insertion (Push-in fitting)

- ①. Make sure that the cut end surface of the tube is at a right angle without a scratch on the tube surface or deformations.
- ②. When inserting a tube, the tube needs to be inserted fully into the push-in fitting until the tubing edge touches the tube end of the fitting as shown in the figure below. Otherwise, there is a risk of leakage.

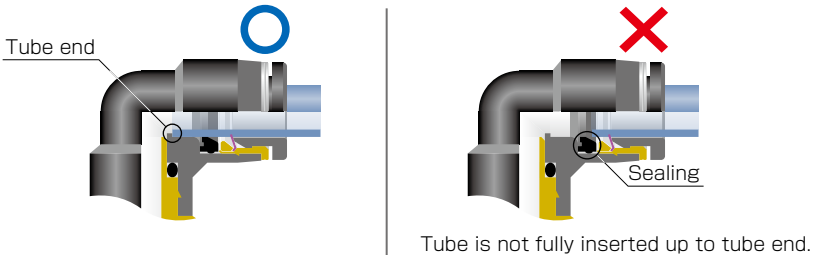

- ③. After inserting the tube, make sure it is inserted properly and not to be disconnected by pulling it moderately.
 - ※. When inserting tubes, Lock-claws may be hardly visible in the hole, observed from the front face of the release-ring. But it does not mean the tube will surely escape. Major causes of the tube escape are the followings; ① Shear drop of the lock-claws edge ② The problem of tube diameter (usually small). Therefore, follow the above instructions from ① to ③, even lock-claws is hardly visible.

7-2. Tube insertion (Compression fitting)

- ①. Make sure that the cut end surface of the tube is at a right angle without deformations or a scratch on its inner and outer surface.

- ②. Pass the tube through the nut and insert the barb into the tube up to the barb end. Then tighten the hexagonal-column of the nut with a proper tool.
- ③. Refer to Table 2 which shows the tightening torque.
 - ※. Hold the tube when tightening the nut, since the tube may rotate along with the nut.
- ④. Make sure that the nut touches the metallic body. If not, loosen the nut, disconnect the tube and start over again from the process ①.
- ⑤. Make sure that there is no leakage after tightening the nut.
- ⑥. After inserting the tube, make sure it is inserted properly and not to be disconnected by pulling it moderately.

● Table 2. Nut tightening torque

Tube O.D.	Tightening torque
ø10	Max.4N·m
ø12	Max.5N·m
ø16	Max.14N·m

8-1. Tube disconnection (Push-in fitting)

- ①. Make sure there is no air pressure inside of the tube, before disconnecting it.
- ②. Push the release-ring of the push-in fitting evenly and deeply enough to pull out the tube toward oneself. By insufficient pushing of the release-ring, the tube may not be pulled out or damaged by scratch, and tube shavings may remain inside of the fitting, which may cause the leakage later.

8-2. Tube disconnection (Compression fitting)

- ①. Make sure there is no air pressure inside of the tube, before disconnecting it.
- ②. Use a proper tool to loosen the nut. Then disconnect the tube.

9. Installation of a fitting

- ①. When installing a fitting, use proper tools to tighten a hexagonal-column or an inner hexagonal socket. When inserting a hex key into the inner hexagonal socket of the fitting, be careful so that the tool does not touch lock-claws. The deformation of lock-claws may result in a poor performance of systems or an escape of the tube.
- ②. Refer to Table 3 which shows the tightening torque. Do not exceed these limits to tighten a thread. Excessive tightening may break the thread part or deform the gasket to cause a fluid leakage. Tightening thread with tightening torque lower than these limits may cause a loosened thread or a fluid leakage. Since the sealability is affected by the processing condition of the installing part, adjust the tightening torque or correct the installing part, according to the condition.
- ③. Adjust the tube direction while tightening thread within these limits, since some PISCO products are not rotatable after the installation.

● Table 3. Tightening torque / Sealock color / Gasket materials

Thread type	Thread size	Tightening torque	Sealock color	Gasket material
Metric thread	M3 × 0.5	0.7N·m	n/a	SUS304+NBR SPCC+NBR
	M5 × 0.8	1 ~ 1.5N·m		
	M6 × 1	2 ~ 2.7N·m		
	M3 × 0.5	0.7N·m		POM
	M5 × 0.8	1 ~ 1.5N·m		
	M6 × 0.75	0.8 ~ 1N·m		
Taper pipe thread	M8 × 0.75	1 ~ 2N·m	White	—
	R1/8	4.5 ~ 6.5N·m		
	R1/4	7 ~ 9N·m		
	R3/8	12.5 ~ 14.5N·m		
Unified thread	R1/2	20 ~ 22N·m	n/a	SUS304+NBR, SPCC+NBR
	No.10-32UNF	1 ~ 1.5N·m		
National Pipe Thread Taper (American standard)	1/16-27NPT	4.5 ~ 6.5N·m	White	—
	1/8-27NPT	4.5 ~ 6.5N·m		
	1/4-18NPT	7 ~ 9N·m		
	3/8-18NPT	12.5 ~ 14.5N·m		
	1/2-14NPT	20 ~ 22N·m		
G thread	G1/4	12 ~ 14N·m	n/a	Aluminum + PBT
	G3/8	22 ~ 24N·m		
	G1/2	28 ~ 30N·m		

※. These values may differ for some products. Refer to each specification as well.

- ④. When removing a fitting, use proper tools to loosen a hexagonal-column or an inner hexagonal socket. When inserting a hex key into the inner hexagonal socket of the fitting, be careful so that the tool does not touch lock-claws. The deformation of lock-claws may result in a poor performance of systems or an escape of the tube.
 - ⑤. Remove the sealant stuck on the mating equipment. The remained sealant may get into the peripheral equipment and cause malfunctions.
10. Handling of fitting
- ①. Impact caused by dropping or the like may lead to damage to the product and a fluid leakage.