

Series 670, 675, 690, 695 Product Overview

Features:

- Precision clamping for high production
- Adjustable collet-type bushing minimizes radial plunger movement
- Plunger has a flat surface for anti rotation
- Pre-load nut and hold open device included

Applications:

- Assembly
- Welding

670-1MBPLS



675-1MBPLS



690-1MBPLS

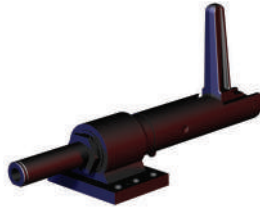

695-1MBPLS ⓘ



Series 670, 675, 690, 695 Technical Information, Holding Capacities

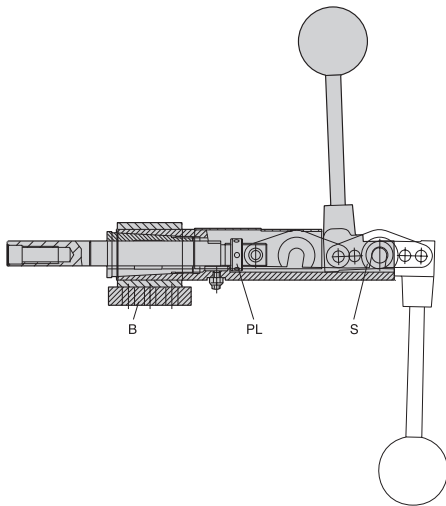

Model	Max. Holding Capacity	Weight	Plunger Travel	Plunger Thread
670-1MBPLS	[2400 lbf] 10680 N	[4.2lb] 1,91kg	[2.25] 57,2	M12
675-1MBPLS		[4.0lb] 1,81kg	[1.10] 28	
690-1MBPLS	[5000 lbf] 22240 N	[8.2lb] 3,72kg	[3.00] 76,2	M16
695-1MBPLS ⓘ		[7.2lb] 3,27kg	[1.50] 38,1	

ⓘ This item is available upon request

The unique feature of these clamps is the collet-type bushing that can be adjusted to eliminate plunger end movement after long repeated use. The plunger also has a flat which prevents lateral movement and allows offset piloting and holding. The plunger is drilled and tapped for threaded spindles or custom fixturing.

The adjustable pre-load nut (PL) can be used to lock the clamp against itself when not under pressure and therefore prevent opening when mounted vertically. The spring hold-open device (S) prevents the clamp from accidentally closing.

The mounting base (B) is supplied disassembled with the four models, to enable welding the base and the main assembly in any handle position.

Series 675 and 695 (shorter stroke) reach the over-center position only when clamping. Series 670 and 690 (longer stroke) lock in both the extended and retracted position.

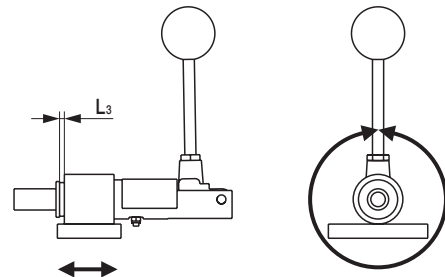

Welding range L_3 axial
0-8mm [0-0.31in.]

Welding range radial 360°

Series 670, 675, 690, 695 Standard Clamp Dimensions

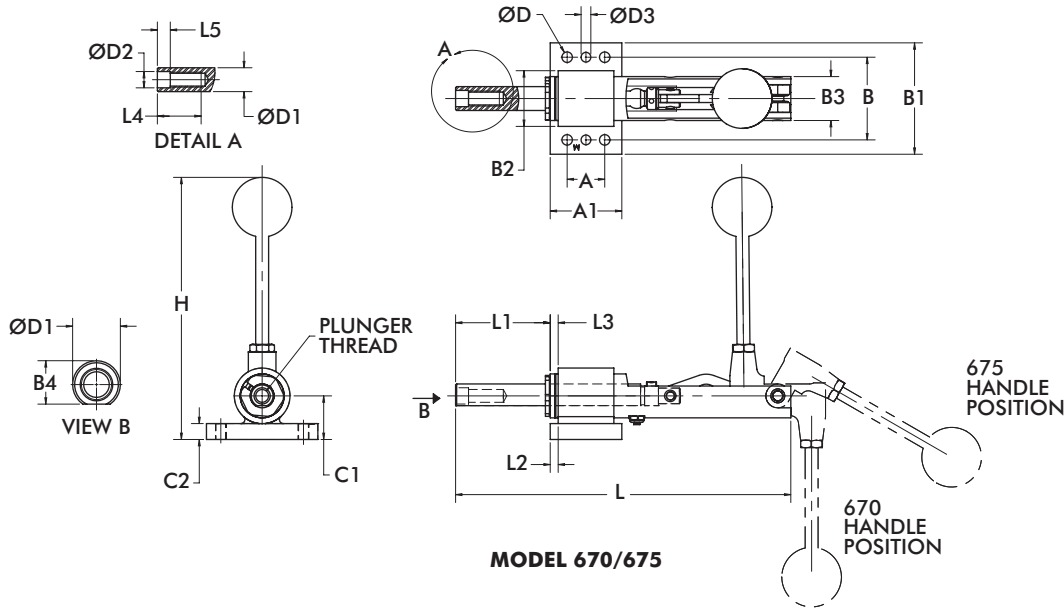

MODEL 670/675

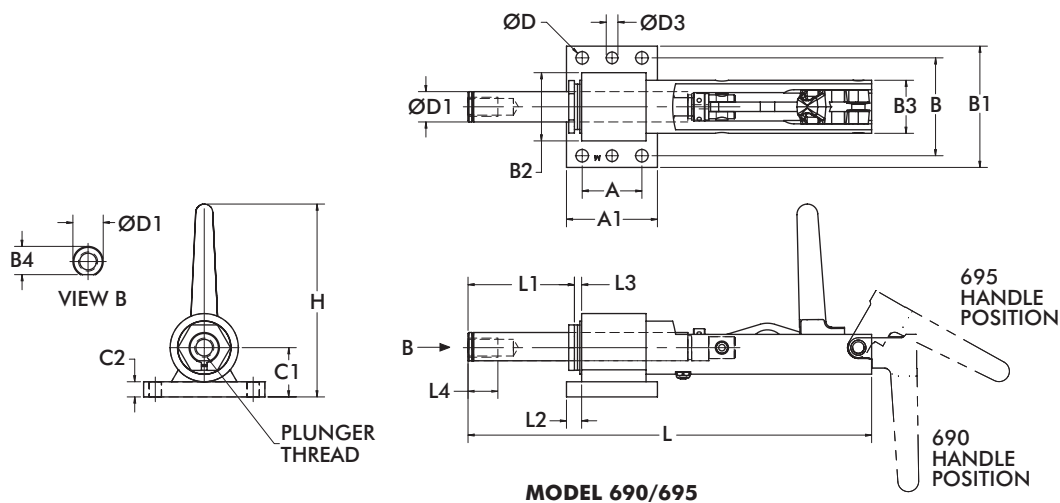

MODEL 690/695

Model	A	A1	B	B1	B2	B3	B4	C1	C2	D	D1	D2H7	D3
670-1MBPLS	[1.18]	[2.24]	[2.60]	[3.50]	[1.75]	[1.38]	[0.68]	[1.37]	[0.50]	[0.33]	[0.75]	[0.51]	[0.31]
675-1MBPLS	30	57	66	89	44,5	35	17,3	34,8	12,7	8,4	19	13	7,8
690-1MBPLS	[1.97]	[3.00]	[3.23]	[4.00]	[2.25]	[1.75]	[0.93]	[1.63]	[0.50]	[0.41]	[1.00]	--	[0.39]
695-1MBPLS	50	76,2	82	101,6	57,2	44,4	23,7	41,3	12,7	10,5	25,4	--	9,8

Model	H	L	L1	L2	L3	L4	L5
670-1MBPLS	[8.11]	[10.55]	[2.97]	[0.25]	[0-0.31]	[1.38]	[0.41]
675-1MBPLS	206	[7.68]	[1.74]	6,4	0-8	35	10,3
690-1MBPLS	[6.37]	[13.31]	[3.69]	[0.50]	[0-0.31]	[0.98]	--
695-1MBPLS	162	[9.45]	[2.25]	12,7	0-8	25	--



FO Series

Type of Mounting:

- Foot mount

Type of Actuation:

- Hand wheel or hand lever (one-handed operation)
- Locking lever and Plunger (two-handed operation)

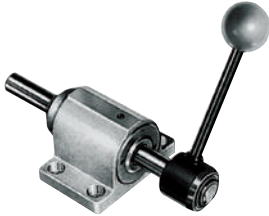

FL Series

Type of Mounting:

- Flange mount

Type of Actuation:

- Locking lever or hand wheel (one-handed operation)
- Locking lever and Plunger (two-handed operation)

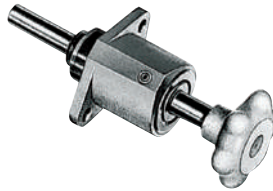

G Series

Type of Mounting:

- Through hole mount

Type of Actuation:

- Locking lever and Plunger (two-handed operation)
- Hand wheel or hand lever (one-handed operation)

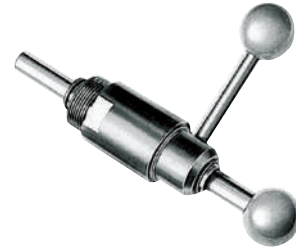

Variable Stroke Straight-Line Action Technical Information

		Model	Holding Capacity max. [lbs] N	Page	Accessories	Model	Page
Flanged base		FO-082-40	[335] 1500	4.3	Plunger 	12/100	4.4
		FO-120	[675] 3000			12/200	
FO-121-45		[675] 3000	12/300				
	FO-122-45	[675] 3000	16/100				
	FO-160	[2020] 9000	16/200				
	FO-161-60	[2020] 9000	16/300				
	FO-162-60	[2020] 9000	16/400				
	FO-220	[4045] 18000	16/500				
	FO-221-80	[4045] 18000	22/100				
			22/200				
			22/300				
Front flange		FL-120	[675] 3000			4.7	
		FL-121-45	[675] 3000	K612			
FL-122-45		[675] 3000	K816				
	FL-160	[2020] 9000	K1222				
	FL-161-60	[2020] 9000					
	FL-162-60	[2020] 9000					
Threaded mount		G-082-40	[335] 1500				
		G-120	[675] 3000				
	G-121-45	[675] 3000					
	G-122-45	[675] 3000					

Model	Holding Capacity max. [lbs] N	Page
F-160	[4,040] 18000	4.3



Two-hand operation
(the plunger and the hand lever are operated separately)

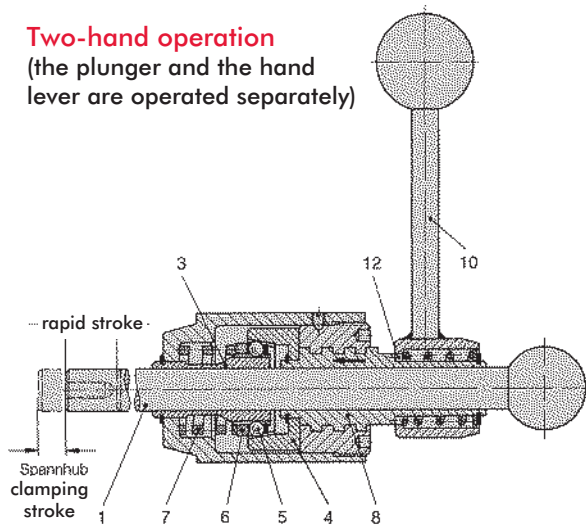

One-hand operation
(the plunger and handle lever/hand wheel are operated simultaneously)

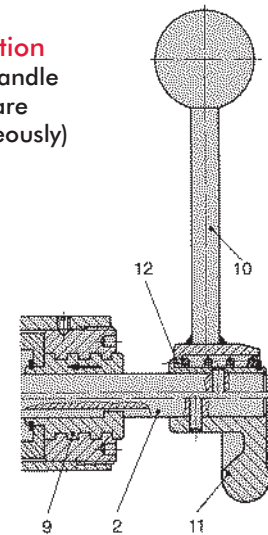

DE-STA-CO's variable stroke straight-line clamps are used in applications where workpiece thicknesses and workpiece tolerances vary. These clamps are suitable for clamping between ribs and hollow spaces difficult to reach.

Compact design and different types of operation allow for application of the straight-line clamps in fixtures for mass production as well as for single part production.

Mounting types

- Foot base (FO Series)
- Flange mount (FL Series)
- Through hole mount (G Series)

Type of operation

- Two hand operation
- The hand lever (10) and the plunger (1) are separate. The hand lever is connected to the clamping mechanism. The plunger can be removed from the clamp
- One-hand operation
- The hand lever (10) or the hand wheel (11) and the plunger (2) are linked. The plunger is retained within the clamp.

Clamping operation

The plunger (1) or (2) which is guided within the clamp body contacts the workpiece. By rotating the hand lever (10) or the hand wheel (11) clock-wise the clamping stroke, S1 is engaged and the plunger is tightly gripped by the slotted clamping sleeve (3).

Operating principle

The hand lever's (10) clock-wise rotation causes the threaded sleeve (8) and the conical sleeve (4) to which it is connected to move in the direction of the arrow shown in the drawing. The conical sleeve produces a force-locking connection between the slotted clamping sleeve (3) and the plunger by means of the ball bearings (5) located at the clamping sleeve's perimeter.

Due to the force-locking connection, the plunger rotates and produces the clamping stroke S1. The plungers rotation may be compensated for by means of a swivel hold-down piece.

The clamping strokes S1 specified in this catalog were measured with no opposing forces present while measurements were taken. When clamping this product against a workpiece, the clamping stroke S1 is reduced by the force-locking connection between the plunger and the workpiece. The straight-action clamp is unlocked by turning the hand lever or the hand wheel counter-clock-wise. This method is used for both the one-hand and the two-hand operation types. This counter-clockwise rotation makes the conical sleeve (4) and the threaded sleeve (8) or (9) move backward. The pressure spring (7) pushes back the relieved ball bearings (5) via the pressure ring (6).

The force-locking connection between the slotted clamping sleeve and the plunger can be moved freely again. Straight-line clamps which are two-hand operated can also be applied to pull actions when the plunger is inserted in the clamp's housing in the opposite direction. On the one hand operated clamp, the rotation inducing the clamping stroke S1 is directly transmitted from the plunger (2) or the hand wheel to the threaded sleeve (9) via a groovespring connection. The clamping and unclamping operations are executed in the same way as described before.

Handling

To change the position of the handle while in the clamped or the unclamped position, pull the hand lever off its spline (12) and set it in the desired position.

Important

The holding forces specified in the catalog refer to the maximum load exerted on the clamp by counter-forces. For details concerning the clamping force FS exerted on the workpiece by the clamp and depending on the operation force FB (manual force), please see the chart on the next page.

The clamping force is proportional to the operation force. The achieved clamping force must not exceed the maximum holding force.

As the straight-line clamps, with the exception of the F-160 model, are designed only for axial load, we recommend to use an additional radial support for the plunger in the event of side load.

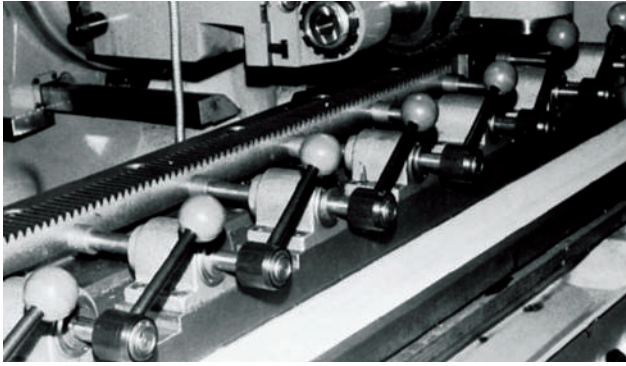

Model FO-161/60 on a milling machine

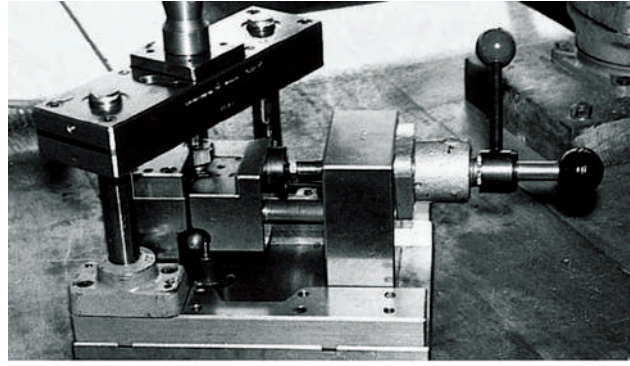

Model FL-160 with plunger 16/100 on a punching fixture

Different Designs



FO Series

Mounting type: flange base foot mount
Operating method: one-hand or two-hand operation



FL Series

Mounting type: front flange mount
Operating method: one-hand or two-hand operation



G Series

Mounting type: through hole mount
Operating method: one-hand or two-hand operation

Mounting type	Operating method			Model	Max. holding capacity [lbs.] N	Clamping force F _s with an operating force F _B		Rapid stroke S [mm]	Max. clamping stroke S1 [mm]	Weight	
	Two-hand operation Plunger and hand lever	One-hand operation Hand lever	One-hand operation Hand wheel			FB [lbs.] N	FS [lbs.] N			[lbs.]	Kg
Foot mount	 	•		•	FO-082-40	[335] 1500	[22] 100	[100] 450	40	2,5	[0.72] 0,325
		•			FO-120¹⁾	[675] 3000		[425] 1900	100, 200, 300	3	[1.19] 0,540
			•		FO-121-45	[675] 3000		[425] 1900	45	3	[1.47] 0,665
				•	FO-122-45	[675] 3000		[100] 450	40	3	[1.34] 0,610
	 	•			FO-160¹⁾	[2020] 9000		[560] 2500	100, 200, 300	4	[2.73] 1,240
			•		FO-161-60	[2020] 9000		[560] 2500	60	4	[3.40] 1,540
				•	FO-162-60	[2020] 9000		[190] 850	60	4	[3.15] 1,430
		•			FO-220¹⁾	[4045] 18000		[675] 3000	100, 200, 300	4	[5.85] 2,655
Flange mount	 	•			FL-120¹⁾	[675] 3000	[425] 1900	100, 200, 300	3	[1.07] 0,485	
			•		FL-121-45	[675] 3000	[425] 1900	45	3	[1.34] 0,610	
				•	FL-122-45	[675] 3000	[100] 450	40	3	[1.21] 0,550	
	 	•			FL-160¹⁾	[2020] 9000	[560] 2500	100, 200, 300	4	[2.49] 1,130	
			•		FL-161-60	[2020] 9000	[560] 2500	60	4	[3.15] 1,430	
				•	FL-162-60	[2020] 9000	[190] 850	60	4	[2.92] 1,325	
Through hole mount	 			•	G-082-40	[335] 1500	[100] 450	40	2,5	[0.66] 0,300	
		•			G-120¹⁾	[675] 3000	[425] 1900	100, 200, 300	3	[1.01] 0,470	
			•		G-121-45	[675] 3000	[425] 1900	45	3	[1.31] 0,595	
				•	G-122-45	[675] 3000	[100] 450	40	3	[1.18] 0,335	



Two-hand operation (the plunger and the hand lever are operated separately)

Through hole mount

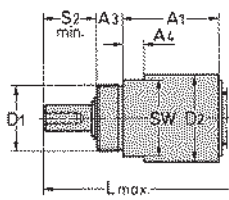

Part no. G-120/--

Flange mount

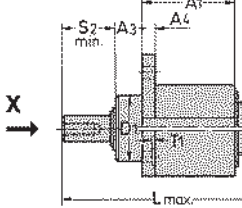

View "X"

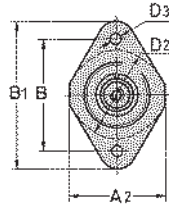

Part no. FL-120/--

View "X"

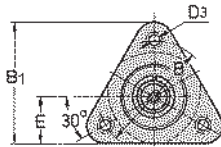

Part no. FL-160/--

Foot mount

*without counter-force effect

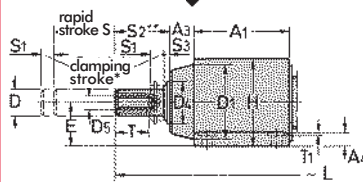

View "Y"

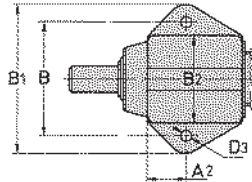

Part no. FO-120/--

View "Y"

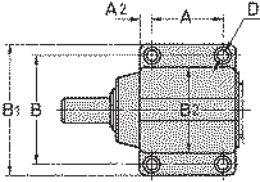

Part no. FO-160/--
FO-220/--

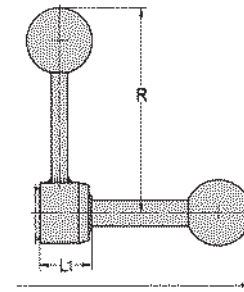

Accessories

(order separately)

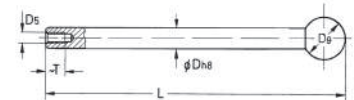

Plunger

Part no. Ø length	For rapid stroke S	Weight ~ [lbs.] kg	For clamps
12/100	100	[0.30] 0,135	FO-120
12/200	200	[0.62] 0,280	FL-120
12/300	300	[0.82] 0,370	G-120
16/100	100	[0.88] 0,400	FO-160
16/200	200	[1.10] 0,500	FL-160
16/300*	300	[1.54] 0,700	
22/100	100	[2.20] 1,000	FO-220
22/200	200	[2.40] 1,090	
22/300	300	[3.06] 1,390	

*400 and 500 mm lengths available upon request.

Important

The straight-line clamps are designed only for **axial load**. In case of side load, we recommend an additional radial support of the plunger.

Mounting type	Part no. without plunger	Available rapid strokes S (order plunger separately)	A	A1	A2	A3	A4	A8	B	B1	B2	Dh8	D1	D2	D3	D4
Foot mount	FO-120	100, 200, 300	-	44	19	12	6,3	8,5	52	68	40	12	35	-	6,5	20
	FO-160	100, 200, 300	40	62	11	12	12	10	70	90	52	16	46	-	9	25
	FO-220	100, 200, 300	50	75	13	20	15	12	90	115	69	22	60	-	11	36
Flange mount	FL-120	100, 200, 300	-	44	44	12	6	8,5	52	68	-	12	30f7	40	6,5	20
	FL-160	100, 200, 300	-	60	-	14	14	10	68	73	-	16	40f7	52	9	25
Through hole mount	G-120	100, 200, 300	-	44	-	12	10	8.5	-	-	-	12	M30 x1,5	40	-	20

Mounting type	Part no. without plunger	D5	D6	E	E1	H	L with rapid strokes:			L1	R	S2	S3	SW	SW1	T	T1	T3
							~	100	200									
Foot mount	FO-120	M6	30	20	12,5	42	228	328	428	24	95	2,5	2,5	-	11	12	-	10
	FO-160	M8	35	30	14,8	58	280	380	480	33	130	3	3	-	13	15	1	14
	FO-220	M12	40	35	19,5	71	295	395	495	35	197	3	3	-	17	25	1	18
Flange mount	FL-120	M6	30	-	12,5	-	228	328	428	24	95	2,5	2,5	-	11	12	-	10
	FL-160	M8	35	28	14,8	-	280	380	480	33	130	3	3	-	13	15	1	14
Through hole mount	G-120	M6	30	-	12,5	-	228	328	428	24	95	2,5	2,5	35	11	12	-	12

One-hand operation (the plunger and the hand wheel are operated simultaneously)

Through hole mount

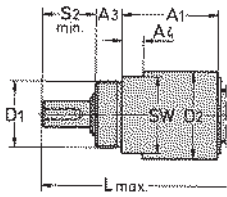

Part no. G-082/40
G-122/45

Flange mount

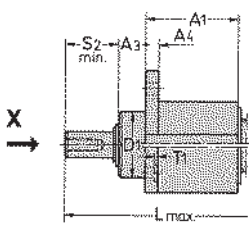

View "X"

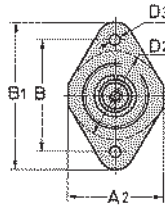

Part no. FL-122/45

View "X"

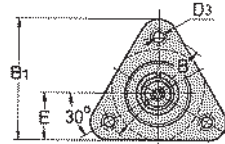

Part no. FL-162/60

Foot mount

*without counter-force effect

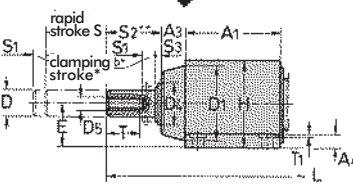

View "Y"

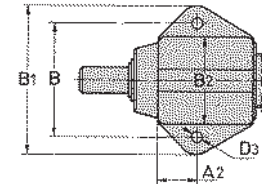

Part no. FO-082/40
FO-122/45

View "Y"

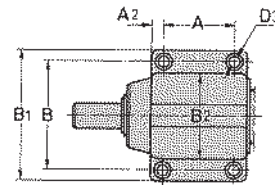

Part no. FO-162/60

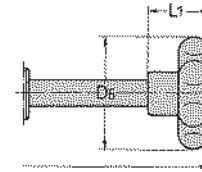

Important
The straight-line clamps are designed only for axial load. In case of side load, we recommend an additional radial support of the plunger.

Mounting type		Part no. with plunger	A	A ₁	A ₂	A ₃	A ₄	A ₅	B	B ₁	B ₂	D _{h8}	D ₁	D ₂	D ₃	D ₄
Foot mount		FO-082-40	-	37	15,3	10	5	6	44	56	35	8	30	-	4,5	16
		FO-122-45	-	44	19	12	6,3	8,5	52	68	40	12	35	-	6,5	20
		FO-162-60	40	62	11	12	12	10	70	90	52	16	46	-	9	25
Flange mount		FL-122-45	-	44	44	12	6	85	52	68	-	12	30f7	40	6,5	20
		FL-162-60	-	60	-	14	14	10	68	73	-	16	40f7	52	9	25
Through hole mount		G-082-40	-	37	-	10	8	6	-	-	-	8	M24x1,5	35	-	16
		G-122-45	-	44	-	12	10	8,5	-	-	-	12	M30x1,5	40	-	20

Mounting type		Part no. with plunger	D ₅	D ₆	E	E ₁	H	L	L ₁	S ₂	S ₃	SW	SW ₁	T	T ₁	T ₃
Foot mount		FO-082-40	M5	40	18	9,2	36	128	26	9	2,5	-	8	8	-	8
		FO-122-45	M6	75	20	12,5	42	153	27	15	2,5	-	11	12	-	10
		FO-162-60	M8	75	30	14,8	58	196	35	18	3	-	13	15	1	14
Flange mount		FL-122-45	M6	52	-	12,5	-	153	27	15	2,5	-	11	12	-	10
		FL-162-60	M8	75	28	14,8	-	196	35	18	3	-	13	15	1	14
Through hole mount		G-082-40	M5	40	-	9,2	-	128	26	9	2,5	30	8	12	-	8
		G-122-45	M6	52	-	12,5	-	153	27	15	2,5	35	11	12	-	10



One-hand operation (the plunger and the hand lever are operated simultaneously)

Through hole mount

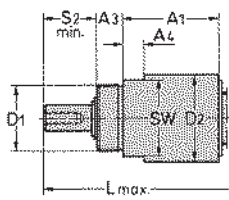

Part no. G-121/45

Flange mount

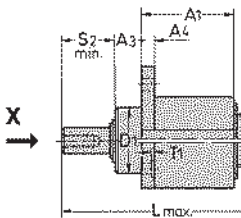

View "X"

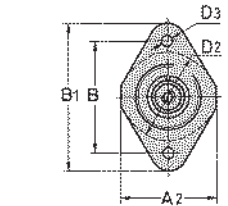

Part no. FL-121/45

View "X"

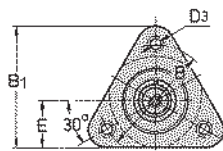

Part no. FL-161/60

Foot mount

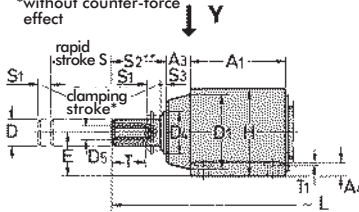

View "Y"

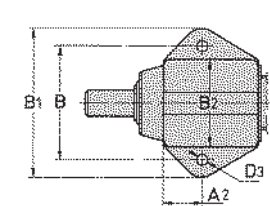

Part no. FO-121/45

View "Y"

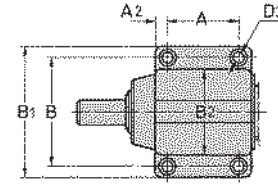

Part no. FO-161/60
FO-221/80

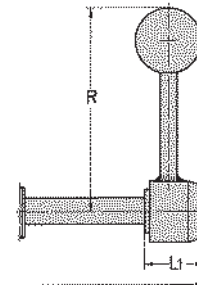

Important

The straight-line clamps are designed only for **axial load**. In case of side load, we recommend an additional radial support of the plunger.

Mounting type	Part no. with plunger	A	A ₁	A ₂	A ₃	A ₄	A ₅	B	B ₁	B ₂	D _{h8}	D ₁	D ₂	D ₃	D ₄
Foot mount	FO-121-45	-	44	19	12	6,3	8,5	52	68	40	12	35	-	6,5	20
	FO-161-60	40	62	11	12	12	10	70	90	52	16	46	-	9	25
	FO-221-80	50	75	13	20	15	12	90	115	69	22	60	-	11	36
Flange mount	FL-121-45	-	44	44	12	6	8,5	52	68	-	12	30f7	40	6,5	20
	FL-161-60	-	60	-	14	14	10	68	73	-	16	40f7	52	9	25
Through hole mount	G-121-45	-	44	-	12	10	8,5	-	-	-	12	M30x1,5	40	-	20

Mounting type	Part no. with plunger	D ₅	E	E ₁	H	L	L ₁	R	S ₂	S ₃	SW	SW ₁	T	T ₁	T ₃
Foot mount	FO-121-45	M6	20	12,5	42	153	27	95	15	2,5	-	11	12	-	10
	FO-161-60	M8	30	14,8	58	196	35	130	18	3	-	13	15	1	14
	FO-221-80	M12	35	19,5	71	245	40	197	20	3	-	17	25	1	18
Flange mount	FL-121-45	M6	-	12,5	-	153	27	95	15	2,5	-	11	12	-	10
	FL-161-60	M8	28	14,8	-	196	35	130	18	3	-	13	15	1	14
Through hole mount	G-121-45	M6	-	12,5	-	153	27	95	15	2,5	35	11	12	-	10

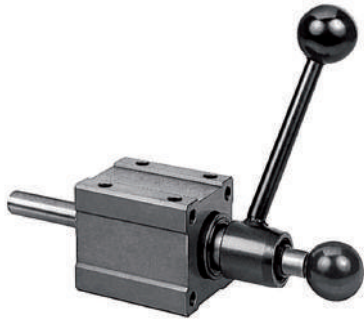

Technical features:

- High holding capacity of [4040 lbf] 18000N lbs.
- High side load capacity
- Plunger guide
- Wiper ring avoiding contamination of clamping mechanism
- Block style base provides for variable mounting
- Low weight due to the aluminium housing
- 50 mm horizontal and vertical hole pattern

Accessories (order separately)

Plunger

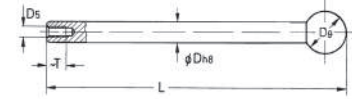

Part no.	For rapid stroke S	D _{H8}	D ₅	D ₉	L	T	Weight ~ [lbs.] kg
16/100	100	16	M8	35	280	15	[0.90] 0,4
16/200	200	16	M8	35	380	15	[1.10] 0,5
16/300*	300	16	M8	35	480	15	[1.54] 0,7

*400 and 500 mm strokes available on request

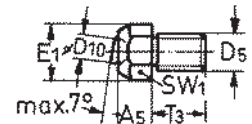

Swivel thrust pad

Part no.	Use with plunger diameter	A ₅	D ₅	D ₁₀	E ₁	T ₃	SW ₁
K-508	8	6	M5	5	9,2	8	8
K-612	12	8,5	M6	6	12,5	10	11
K-816	16	10	M8	8	14,8	14	13
K-1222	22	12	M12	9,5	19,5	18	17

Allowable side load F_s depending on the stroke length L_H

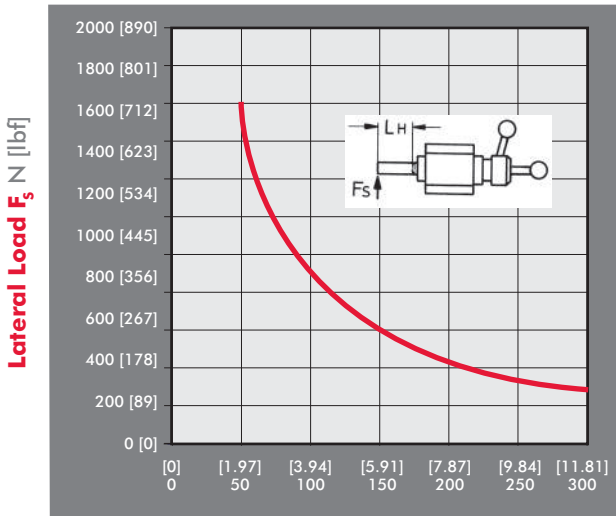

Stroke Length L_H mm [in]

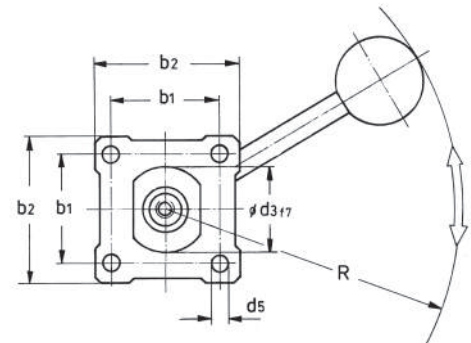
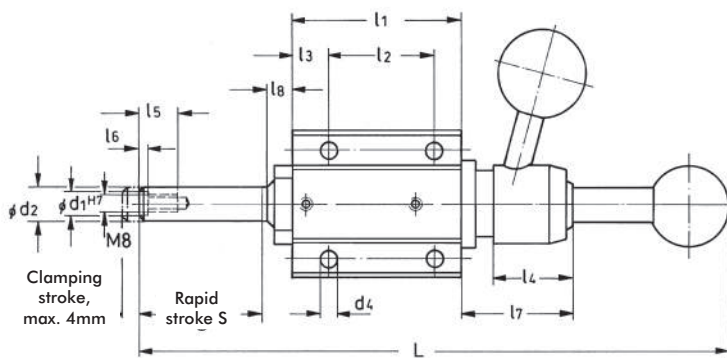

Part no. without plunger	Max. holding cap. [lbs] N	F _s * [lbs] N	~L													d ₁ ^{H7}	d _{2H8}	d ₃	d ₄	d ₅	R	Weight ~ [lbs.] kg
			b ₁	b ₂	For rapid strokes: 100			200			300											
F-160	[4040] 18000N	[110] 500N	50	68	250	350	451	80	50	18	35	20	2	50	12	10	16	40	8,3	8,5	165	[3.30] 1,5

*F_s=exerting force at an operating force of [22lbf] 100N.